

PRODUCTS FOR THE PRINTING INDUSTRY



Rosmini

GRAPHIC SUPPLY CORP.

Phone: 631.789.4200 • 1.800.235.8605 • Fax: 631.789.3551
e-mail: sales@rosminigraphics.com • web: www.rosminigraphics.com



Rosmini GRAPHIC SUPPLY CORP.

Rosmini Graphic Supply Corporation has been servicing the printing industry for over 20 years.

Our commitment at Rosmini is to satisfy our customers' expectations – and doing it on time. Customer satisfaction with quality products, competitive pricing and fast delivery will help us to achieve our mission of becoming the leading worldwide graphic arts supplier.

At Rosmini Graphic Supply Corporation you will always have the most complete and up-to-date products that the industry has to offer at your fingertips. In addition, our expert staff is always ready to assist you in getting what you need - the first time.

Our Goals:

- Customer satisfaction
- Quality products
- Knowledgeable product support
- Competitive pricing
- Fast delivery

Contents

Press Parts	.2
Heidelberg Quickmaster 46 & Printmaster DI Feedboard Tapes, Slowdown Belts	.6
Feedboard Tapes, Anilox Coater End Seals & Gaskets	.7
Sheetfed Offset Anilox Coater Doctor Blades	.8, 9
Keyless Offset Blades, Wash-Up Blades	.10
Cleanup Mats	.11
Hickey Picker Products	.12
Filters	.13-15
Recirculation Filters	.16, 17
Hand Cleaners	.17
Pressroom Accessories	.18-25
Suckers	.26-28
Sheet Separators	.29-30
Air Compressors and Vacuum Pumps	.31
Ionix Static Eliminator	.32
Spray Powders	.32
Anti-Static, Anti-Marking	.33
Litho-Score/Litho-Perf	.34
Packing Gauges	.35
Dampening Covers	.35
Plate and Blanket Packing	.36
Lubricants	.37
Chemicals	.38-43
Storage Cabinets	.44-45
Storage Cans	.46
ROYSE parts	.47
Gripper Fingers	.48-49
Brushes	.50-51
Cutter Supplies	.52
Vs Series Inks	.53
Proofing Media	.54-55
Index	.56

Ink Fountain Liner

Our liners are manufactured to high tolerances from top-grade PET material ensuring:

- Maximum chemical, thermal and mechanical strength for long life without ink duct contamination.
- Only virgin resin suppliers are used - no recycled polyester.
- Tested using both conventional and UV inks.
- Permanently formed for a secure & accurate fit.
- Compact, low volume packaging for safe, easy and cost effective transportation and storage.



For all Heidelberg CPC equipped presses

PART#	INK DUCT FOIL FOR:	SIZE	QUANTITY
FOILQM	Heidelberg QM 46	358 x 200 mm	100 foil/box
FOILGT052	Heidelberg GT052	547 x 200 mm	100 foil/box
FOILS52N	Heidelberg SM52	547 x 197 mm	100 foil/box
FOILMO	Heidelberg MO	676 x 200 mm	100 foil/box
FOIL72	Heidelberg SM72	775 x 232 mm	100 foil/box
FOIL74	Heidelberg CD74	775 x 228 mm	100 foil/box
FOIL75	Heidelberg XL75	775 x 229 mm	100 foil/box
FOIL102	Heidelberg SM102	1068 x 232 mm	100 foil/box
FOIL102CD	Heidelberg SM102CD	1068 x 229 mm	100 foil/box
FOIL105	Heidelberg XL105	1068 x 229 mm	100 foil/box
FOILW8	WEB 8	548 x 260 mm	50 foil/box
FOILW110	MC-110	740 x 260 mm	50 foil/box
FOILW130	WEB 130	994 x 260 mm	50 foil/box
FOILW16	WEB 16 / M600	1002 x 260 mm	50 foil/box
FOIL25QM	Heidelberg QM 46	358 x 200 mm	100 foil/box
FOIL25GT052	Heidelberg GT052	547 x 200 mm	100 foil/box
FOIL25S52N	Heidelberg SM52	547 x 197 mm	100 foil/box
FOIL25MO	Heidelberg MO	676 x 200 mm	100 foil/box
FOIL2572	Heidelberg SM72	775 x 232 mm	100 foil/box
FOIL2574	Heidelberg CD74	775 x 228 mm	100 foil/box
FOIL2575	Heidelberg XL75	775 x 229 mm	100 foil/box
FOIL25102	Heidelberg SM102	1068 x 232 mm	100 foil/box
FOIL25102CD	Heidelberg SM102CD	1068 x 229 mm	100 foil/box
FOIL25105	Heidelberg XL105	1068 x 229 mm	100 foil/box
FOIL25W8	WEB 8	548 x 260 mm	50 foil/box
FOIL25W110	MC-110	740 x 260 mm	50 foil/box
FOIL25W130	WEB 130	994 x 260 mm	50 foil/box
FOIL25W16	WEB 16 / M600	1002 x 260 mm	50 foil/box
FOIL30QM	Heidelberg QM 46	358 x 200 mm	50 foil/box
FOIL30GT052	Heidelberg GT052	547 x 200 mm	50 foil/box
FOIL30S52N	Heidelberg SM52	547 x 197 mm	50 foil/box
FOIL30MO	Heidelberg MO	676 x 200 mm	50 foil/box
FOIL3072	Heidelberg SM72	775 x 232 mm	50 foil/box
FOIL3074	Heidelberg CD74	775 x 228 mm	50 foil/box
FOIL3075	Heidelberg XL75	775 x 229 mm	50 foil/box
FOIL30102	Heidelberg SM102	1068 x 232 mm	50 foil/box
FOIL30102CD	Heidelberg SM102CD	1068 x 229 mm	50 foil/box
FOIL30105	Heidelberg XL105	1068 x 229 mm	50 foil/box
FOIL30W8	WEB 8	548 x 260 mm	50 foil/box
FOIL30W110	MC-110	740 x 260 mm	50 foil/box
FOIL30W130	WEB 130	994 x 260 mm	50 foil/box
FOIL30W16	WEB 16 / M600	1002 x 260 mm	50 foil/box

Protective Underlay Foil



Two-band bi-adhesive for placement under ink duct foil. 70mm wide x 25m per roll. Packed in clear plastic box for safe storage. Also available in packs of 12 pieces cut to individual press size. Packing: 1 Roll

Part# 2PUNPF 00.472.006

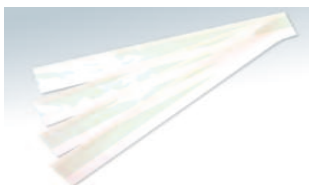

New style protective underlay foil for Heidelberg SM102 and SM74
Packing: 12 pieces per box

Part# 2PUNPF102N 82.008.119F
Part# 2PUNPF74N

Ink Fountain Duct Insulating Strip



A bi-adhesive for placement under the edge of the ink duct end block. Packing alternatives:

Part# 2DUCT 91.008.044/A
10 pcs/pack @150mm x 16mm
Part# 2DUCT150
150 pcs/pack @150mm x 16mm

Tesamol Strip



An adhesive foam for placement under the ink duct foil. 9mm x 6mm x 10m/roll Packed in a convenient clear plastic box for safe storage.

Part# 2TESAM 00.580.1010

Scraper Cleaner



For ink duct fountain roller on Heidelberg sheet fed presses.

Packing: 25 pieces per pack

Part# 2CSHEET 91.008.033



For ink duct fountain roller on Heidelberg WEB16

Packing: 25 pieces per pack

Part# 25CWEB16 WM4ME008054

Ink Fountain Side Plate Tape



A bi-adhesive for placement under the edge of the ink duct end block.
(72 yard/rolls)

Part# IF449 04.024.061

Grease Gun



All Heidelberg offset presses

Part# HE4061 03.024.061

Oil Gun



All Heidelberg offset presses

Part# HE4062 03.024.062

Lay Pins

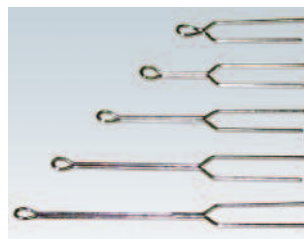

Part#	Size
LP02146	Length 35mm
LP02147	Length 45mm
LP02148	Length 55mm
LP02149	Length 65mm
LP02150	Length 75mm

Packing: 25 pcs/bag

Ink Fountain Plates

Ink side plates are made of the highest quality engineering grade plastic polymer ensuring long life expectancy and the ability to endure high cyclic stress loading, all translating into cost savings for the printer. All side plates come complete with tabs, screws and scraper cleaners ready for mounting on the press.



Model: Heidelberg PrintMaster 46
Dampening seals
Packing: 1 Set (DS/OS)

Part# SEAL46PM MV.034.739



Model: Heidelberg QuickMaster 46
Dampening seals
Packing: 1 Set (DS/OS)

Part# SEAL46QM MV.027.163



Left and right spare tabs with screws
1 set with screws/bag

Part# 2IBTAB



Model: Heidelberg QM46-DI
1 pair/bag

Part# 2IBQM46DI A4.008.323 - O/S
A4.008.324 - D/S



Model: Heidelberg QM46-DI
1 pair/bag

Part# 2IBQM46 AI.008.104/01

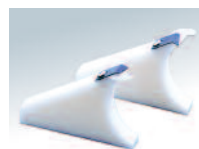

Model: Heidelberg GT052 without CPT
1 pair/bag

Part# 2IBGTOOB MV.037.346



Model: Heidelberg GT052 with CPC and CPT
1 pair/bag

Part# 2IBGTOOC MV.022.805



Model: Heidelberg SM52 with CPC and CPT
1 pair/bag

Part# 2IBSM52CC G2.008.113 F/ - O/S
G2.008.112 F/ - D/S



Model: Heidelberg MO
1 pair/bag

Part# 2IBMO 63.008.113



Model: Heidelberg MO
1 pair/bag

Part# 2IBMO2 S/N 608117+



Model: Heidelberg SM74
1 pair/bag

Part# 2IB74 M2.008.113F/02



Model: Heidelberg SM74CD
1 pair/bag

Part# 2IB74CD L2.008.114F - O/S
L2.008.113F - D/S



Model: Heidelberg SM102 & SM72
1 pair/bag

Part# 2IB102/72 MV.025.468



Model: Teflon seal sets for Kompac II Systems
1 pair/bag

Part# 2IBVKSM 92370



Model: Teflon seal sets for Kompac III Systems (GTO/MO)
1 pair/bag

Part# 2IBVKGTO 90850



Model: Cleaning seals for Kompac II Systems
25pcs/bag

Part# 2IBVKCSMP 93930



Model: Cleaning seals for Kompac III Systems
25pcs/bag

Part# 2IBVKCGTO 94900

Cylinder Jackets for Heidelberg Presses

Available for immediate delivery for most Heidelberg presses

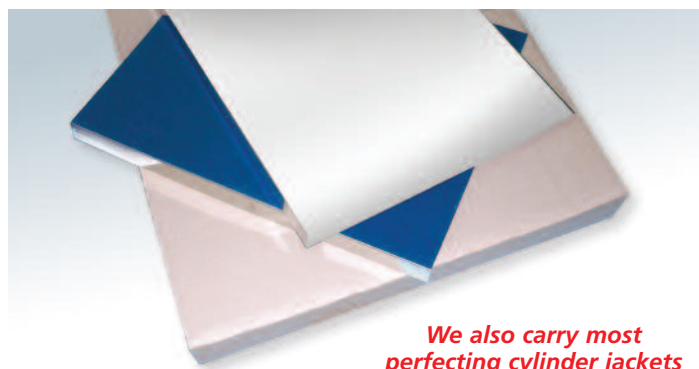

PRESS	MODEL	METAL & THICKNESS	SIZE (cm width)	SIZE (cm length)
HEIDELBERG	PRINTMASTER 46	Steel 0.3	36	46
	PRINTMASTER 52	Steel 0.3	36	52
	GTO 46	Steel 0.3	32	46
	GTO 52	Steel 0.3	36	52
	SM 52	Steel 0.3	36	52
	MO 65	Steel 0.3	48	65
	SM 72	Steel 0.3	52	72
	SM 74	Steel 0.3	52	74
	SM 102	Steel 0.3	72	102
	KOR	Steel 0.6	40	57
	KORA 57	Steel 0.6	46	57
	KORD 62	Steel 0.6	46	62
	KORD 64	Steel 0.6	46	64
	KORS 72	Steel 0.6	52	72
	KS	Steel 0.6	38	52
	KSB	Steel 0.6	40	57
	KSBA	Steel 0.6	46	58.5
	KSBAZ	Steel 0.6	46	57
	KSD	Steel 0.6	46	64
	S (OHZ)	Steel 0.6	54	72
	SB-SBG	Steel 0.6	56	77
	SBG	Steel 0.6	54	77
	SBB	Steel 0.6	57	82
	SBD	Steel 0.6	64	90
	SBD (SPECIAL)	Steel 0.6	64	89
	ROLAND	PRACTICA 00	Steel 0.3	36
PRACTICA 00 (NEW)		Steel 0.3	36	52
PRACTICA 00 2COL		Steel 0.3	36	52
PRACTICA 01		Steel 0.3	48	66
RFOB		Steel 0.3	52	72
REKORD		Steel 0.3	72	103
FUJI- SHINOHARA	FUJI-52	Steel 0.3	36	52
	FUJI-66	Steel 0.3	48	66
SAKURAI	OLIVER 6	Steel 0.3	32	48
	OLIVER 52	Steel 0.3	36	52
	OLIVER 58-258	Steel 0.3	44	58
	OLIVER 66	Steel 0.3	46	66
	OLIVER 72	Steel 0.3	52	72
ROTAPRINT	R 37 KV	Steel 0.3	35	50
HAMADA	ALFA 52	Steel 0.3	36	52
	ALFA 66	Steel 0.3	45	66
KOMORI	SPRINT 26	Steel 0.3	46	68
	SPRINT 28	Steel 0.3	52	72
DAVIDSON	501	Steel 0.3		
	701	Steel 0.3		
TOKO	TOKO	Steel 0.3		
HASHIMOTO	521	Steel 0.3		

Delivery Blowdown Fans

Part# FAN102T
Part# FAN102W



a) FAN102T C2.115.1411



b) FAN102W 93.115.241

Model: Heidelberg SM102,
MO & GTO

Description: Fan for SM102,
MO & GTO delivery
w/terminal
connection

Model: Heidelberg SM102,
MO & GTO

Description: Fan for SM102,
MO & GTO delivery
w/wire connection

Packing: 1 fan/box

Close up picture of the two
types of connections:

- a) Terminal (for CD SM102
s/n540xxx+)
- b) Wire (for SM102 s/n 508803+)

Brush Wheels



Model: Heidelberg SM102,
74 and 72

Description: White brush feeder
wheel with soft bristles for paper

Packing: 1 piece

Part# BWHEIWHITE 66.020.122



Model: Heidelberg SM102,
74 and 72

Description: Black brush feeder
wheel with hard bristles for card
board

Packing: 1 piece

Part# BWHEIBLACK 66.891.006



Description: Komori 40 LS Brush
wheel

Size: 1" od x 3/8" width x 1/4"

Packing: 5 piece

Part# KBWA90

O-Rings



Model: Heidelberg SM102, GTO,
MO and SM52

Description: Slowdown O-rings
for delivery

Packing: 6 pieces per bag

Part# ORSM102 00.580.1617
ORSM52 00.580.4270
ORMO/GTO 00.580.1069

Rubber Feedboard Wheels



Used on Heidelberg
Feedboard

Part# RW125

Pneumatic Springs



Model: Heidelberg SM102
Length: 420mm/16 1/2"
For SM102 Safety guard

Packing: 1 piece

Part# LIFTGUARD 00.580.2722



Model: Heidelberg SM102
Length: 300mm/11 7/8"
For SM102 delivery

Packing: 1 piece

Part# LIFTDEL 00.580.3118

Gripper Pad Gauge



Model: Heidelberg
CD102, SM102/72, S-OFFSET
Description: (paper/cardboard)

Packing: 1 piece per box

Part# GPGHEI 27.024.005

Feeler Gauge for Heidelberg Presses



Press type: Heidelberg Feeler
Gauge

Size: .004 (10mm)

Part# FG10MM

Coater Blades



Model: SM102
Description: Coater blade -
large (Rakel) for coating tower -
drive side

Packing: 1 piece

Part# COATLDS C4.721.074 D/S



Model: SM102
Description: Coater blade -
large (Rakel) for coating tower -
operator side

Packing: 1 piece

Part# COATLOS C4.721.075 O/S



Model: SM102
Description: Coater blade -
small (Rakel) for coating tower -
drive side

Packing: 1 piece

Part# COATSDS C4.721.091 D/S



Model: SM102
Description: Coater blade -
small (Rakel) for coating tower -
operator side

Packing: 1 piece

Part# COATSOS C4.721.092 O/S

Sheet Hold Downs

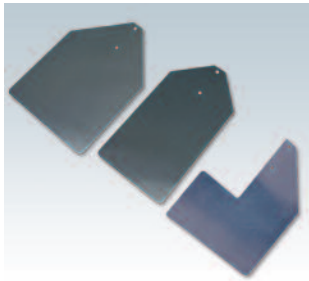

Model: Heidelberg offset presses
Description:
HSHL-Sheet hold down: large
HSHS-Sheet hold down: small
HSHLL-Sheet hold down: lateral

Packing: 1 piece per box

Part# HSHL 66.072.096
Part# HSHS 58.022.396
Part# HSHLL



Description: Lateral - Left - Complete Assembly
Part# HSHLLCL

Description: Lateral - Right - Complete Assembly
Part# HSHLLCR

Description: Large - Complete Assembly
Part# HSHLC OEM# 66.072.084F

Pin Wrenches: Heidelberg



Replacement Pin Wrenches for Heidelberg presses. Made of the highest quality steel.

Part #	Description
A) 2421	Bent Type 4-1/2" Long 4mm on both ends
A) 24503	Bent Type 8" 4mm both ends
B) 2420	Straight Type 7" Long 6mm/4mm
C) 531	Pin Wrench for Plate Cylinder Speed Clamps
D) ST1003	10mm Open End Wrench

Pin Wrenches: Komori



Komori Open End
Pinwrench 8mm

Part# PW516

Circulation Pumps



Roysce, Dahlgren, Baldwin—new and rebuilt, in stock and available for immediate delivery. We also rebuild pumps. Please call for information.



Control Buttons

Part #	Description
B915114B	Heid CPC Consol (Rectangular 4 Prong)
B915114	Heid CPC Consol Ink Control (4 Prong)
SD2C1R	Emergency Stop 35mm
SDD2F2S	Push and Rotate to Maintain
SD2A2S	Push Forward (Black)
SD2H2Y	Turn for 2 Position Yellow - Button only
SD2A2U	Push Button Full Guard
SD3G2S	2 Way Selector Switch
SD3G3S	3 Way Selector Switch
SD2E1B	Blue Toggle Switch
SD2E1W	White Toggle Switch
BULB28V	Heid CPC Button BI Pin Bulb 28V (1 piece)
BULB12V	Heid CPC Button BI Pin Bulb 12V (1 piece)

Replacement Bulbs

- Platemakers and printers
- Paper cutters
- Light boxes
- Scanners for color separation
- Reprographic
- Halogen lamps
- Indicator lights
- Laser printing & phototypesetting
- UV, infrared curing and drying systems
- General lighting
- Fluorescent lamps and ballasts
- Blueprinting and white printing
- Camera projectors and microfiche

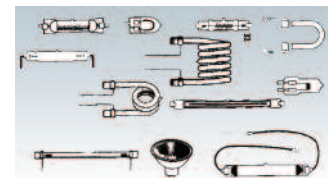

Press Dollies

Press Dollies for Heidelberg and other makes are precision-crafted to save you dollars.

They feature:

- Durable steel-bearing casters
- Laminated exterior
- Steel pick-up bars
- Bumper guards
- Easy-carrying handles
- 12-ply hardwood platforms—our 11/4" thick platforms match the strength of steel because we makethem from 12 plies of top-quality hardwood with the grain laid at cross-directions. A platform made for the heftiest Heidelberg model can carry more than a half-ton of weight.
- Precision design—our press dollies were designed with the help of a certified Heidelberg service technician.
- Two-year guarantee—we're so confident that our press dollies will work reliably under normal press-room conditions that we guarantee them against defect for two (2) years. Our guarantee includes free replacement of the platform, handles, wheels and all steel parts.



HEIDELBERG QUICKMASTER 46 & PRINTMASTER DI



QM 46 & DI Dampening Seals (set)
Part# **SEAL46QM** MV.027.163

Printmaster 46 Dampening Seals (set)
Part# **SEAL46PM** MV.034.739

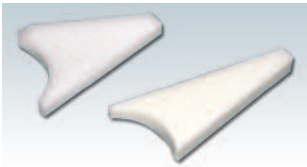

QM 46 DI Ink Fountain Side Plates (set)
Part# **21BQM46-DI** A4.008.323
A4.008.324

QM 46 Ink Fountain Side Plates (set)
Part# **A1.008.104** 21BQM46

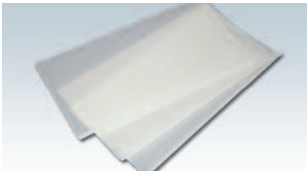

QM 46 Ink Fountain Liners (100/box)

Part# **FOILQM**



QM 46 Wash Up Blades

Part# **WB1510-5**

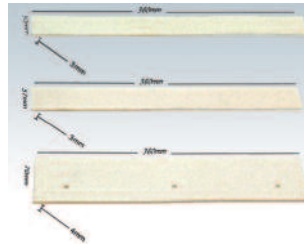

Cleaning felt for PM46 (10/pack)
Part# **FELTPM46**

Cleaning felt for QM46 (10/pack)
Part# **FELTQM46**

Cleaning felt for QM DI 46(10/pack)
Part# **FELTQM46DI**

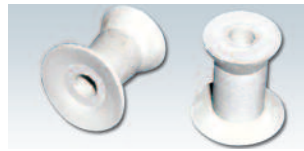

#92Q Suckers for Heidelberg QM46

Part# **SU92Q**



QM 46 Glass Beaded Foil (12/pack)

Part# **GBQM46**



Heid QM 46 Air Filter #317856
A - Part# **F317856**

Heid QM 46 Air Filter #317900
B - Part# **F317900**

SLOW DOWN BELTS



M2.015.880

Green Flat, For CD102, XL105
Size: 235mm x 20mm
Part No: **FBSSFYL** - 1 pc
Part No: **FBSSCFYL** - 3 pcs



M2.015.895

Yellow, 5mm raised, For CD74, CD102, SM52, SM74, XL105
Size: 225mm x 20mm
Part No: **FB74SSY5** - 1 pc
Part No: **FB74SSC3Y5** - 3 pcs



M2.015.898

Grey, 5mm raised, For CD74, SM52
Size: 225mm x 20mm
Part No: **FB74SSG5** - 1 pc
Part No: **FB74SSC3G5** - 3 pcs



C3.015.653

Blue, 13mm raised compressible For SM102, SM74
Size: 215mm x 38mm
Part No: **FB102SSC** - 1 pc



M2.015.357/01

Pink, 10mm raised center band For CD74
Size: 220mm x 38mm
Part No: **FB102SSP** - 1 pc



F4.514.578F

Grey, flat, For CD74, CD102, XL105
Size: 225mm x 20mm
Part No: **FB74SSFY** - 1 pc
Part No: **FB74SSFC3G** - 3 pcs



M2.015.878

Yellow, flat, For CD74, CD102, XL105
Size: 225mm x 20mm
Part No: **FB74SSFY** - 1 pc
Part No: **FB74SSFC3Y** - 3 pcs



M2.015.871

Grey, 9mm raised, For CD74, CD102, SM52, SM74, XL105
Size: 225mm x 20mm
Part No: **FB74SSG** - 1 pc
Part No: **FB74SSC3G** - 3 pcs



M2.015.870

Yellow, 9mm raised, For CD74, CD102, SM52, SM74, XL105
Size: 225mm x 20mm
Part No: **FB74SSY** - 1 pc
Part No: **FB74SSC3Y** - 3 pcs



M2.015.872/01

Grey, 1.5mm raised, For CD74, CD102, SM52, SM74, XL105
Size: 225mm x 20mm
Part No: **FB74SSGRS** - 1 pc
Part No: **FB74SSC3GRS** - 3 pcs



CD102 s/n 543064+ SM74 s/n 621124+

Green Perforated For SM102, SM74
Size: 215mm x 37mm
Part No: **FB102SS** - 1 pc

Komori



Grey, 7mm raised, 26 holes
Size: 210mm x 14mm
Packing: 1 pc
Part No: **FBKS**



Grey, 11mm raised, 26 holes
Size: 210mm x 14mm
Packing: 1 pc
Part No: **FBKD**



Grey, 5mm raised, 35 holes
Size: 210mm x 14mm
Packing: 1 pc
Part No: **FBKX**



Grey, 8mm raised, 52 holes
Size: 210mm x 14mm
Packing: 1 pc
Part No: **FBKN**

FEEDBOARD TAPES

Feedboard Tapes: Heidelberg



Part #	Description
FBGTO	Heidelberg GTO
FBSM52	Heidelberg SM52
FB58054	Heidelberg MO
FB58055	Heidelberg Sork/ Sorm/Sord single color
FB58053	Heidelberg 102/72 (2/colors & up)SORMZ
SDB102	Sheet Slow Down Belt Heidelberg SM102
SDB74	Sheet Slow Down Belt Heidelberg SM74 (3/set)

Feedboard Tapes: Man Roland



Part #	Description
FB300	Man Roland 300
FB600	Man Roland 600
FB700	Man Roland 700

Feedboard Tapes: Komori



Part #	Description
FBKL440	Komori 40"
FBKL28	Komori 28"
FB1300	Komori 26" Sprint
FB3Z06900160	Komori 26" Lithrone

Feedboard Tapes: Mitsubishi



Part #	Description
FBMIT3F/E	Mitsubishi 3F/3E
FBMITIF	Mitsubishi 1F
MITIFG28	Mitsubishi 28

Iron for Feedboard Tapes

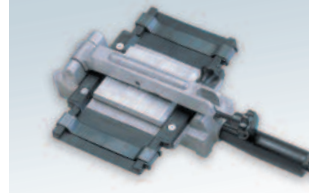

Designed to fit all types of feedboard tapes. To operate, just plug in and clip in feedboard tape along guide (simple to use).

Part# IRON

Glue for Feedboard Tapes



Heat activated glue to permanently bond feedboard tape together.

Part# FB2

ANILOX COATER END SEALS & GASKETS



TRESU

OEM PART NUMBER	PART NUMBER	DESCRIPTION
4000028/0972204	#03.TS.D2.UNIVERS	Universal EPDM Tresu D2 Chamber
	#03.TS.D2.FELT.50	Universal Felt Tresu D2 Chamber
4000024/0972001	#03.TS.D2.UNIVERS	Universal EPDM Tresu D2 Chamber
	#03.TS.D2.FELT.50	Universal Felt Tresu D2 Chamber
4000042/0973206	#03.TS.D3.FELT.50	Universal Felt Tresu D3 Chamber
4000029/0973001	#03.TS.D3.FELT.50	Universal Felt Tresu D3 Chamber
4000047/0974202	#03.TS.D4.FELT.50	Universal Felt Tresu D4 Chamber
4000044/0974001	#03.TS.D4.FELT.50	Universal Felt Tresu D4 Chamber
4000051/0975201	#03.TS.D5.FELT.50	Universal Felt Tresu D5 Chamber
4000050/0975001	#03.TS.D5.FELT.50	Universal Felt Tresu D5 Chamber

HEIDELBERG

Harris & Bruno

PRESS MODEL	PART NUMBER	DESCRIPTION
CD 102	#03.HB.PF.CUST-891-09	Heidelberg CD102 Pre-Soaked Felt Seal
	#03.HB.BF.CUST-795-01	Heidelberg CD102 Blue Foam Seal
SM 102	#03.HB.PF.CUST-153-09	Heidelberg SM102 Pre-Soaked Felt Seal
	#03.HB.BF.SF9B-01	Heidelberg SM102 Blue Foam Seal

Anicolor

SM 52 Anicolor	#03.HG.F.ANICOLR.100	Anicolor Foam Seals
----------------	----------------------	---------------------

KBA

Harris & Bruno

Rapida 75	#03.HB.PF.CUST-848-09	KBA Rapida 75 Pre-Soaked Felt Seal
	#03.HB.BF.CUST-847-01	KBA Rapida 75 Blue Foam Seal
Rapida 105	#03.HB.PF.CUST-701-09	KBA Rapida 105 Pre-Soaked Felt Seal
	#03.HB.BF.CUST-700-01	KBA Rapida 105 Blue Foam Seal
Rapida 105P	#03.HB.PF.CUST-712-09	KBA Rapida 105P Pre-Soaked Felt Seal
	#03.HB.BF.CUST-711-01	KBA Rapida 105P Blue Foam Seal
Rapida 130	#03.HB.PF.CUST-288-09	KBA Rapida 130 Pre-Soaked Felt Seal
	#03.HB.BF.SF17B-01	KBA Rapida 130 Blue Foam Seal

KBA

Harris & Bruno

PRESS MODEL	PART NUMBER	DESCRIPTION
Rapida 142	#03.HB.PF.CUST-703-09	KBA Rapida 142 Pre-Soaked Felt Seal
	#03.HB.BF.CUST-702-01	KBA Rapida 142 Blue Foam Seal
Rapida 162	#03.HB.PF.CUST-703-09	KBA Rapida 162 Pre-Soaked Felt Seal
	#03.HB.BF.CUST-702-01	KBA Rapida 162 Blue Foam Seal
Rapida 205	#03.HB.PF.CUST-706-09	KBA Rapida 205 Pre-Soaked Felt Seal
	#03.HB.BF.CUST-705-01	KBA Rapida 205 Blue Foam Seal

Genius

Genius 52 UV	#03.KB.GENIUS52	KBA Genius 52 End Seal (50 pcs)
--------------	-----------------	---------------------------------

KOMORI

Harris & Bruno

L28	#03.HB.PF.CUST-80-09	Komori L28 Pre-Soaked Felt Seal
	#03.HB.BF.CUST-79-01	Komori L28 Blue Foam Seal
L40	#03.HB.PF.CUST-90-09	Komori L40 Pre-Soaked Felt Seal
	#03.HB.BF.SF9A-01	Komori L40 Blue Foam Seal
LS29	#03.HB.PF.CUST-80-09	Komori LS29 Pre-Soaked Felt Seal
	#03.HB.BF.CUST-79-01	Komori LS29 Blue Foam Seal
LS40	#03.HB.PF.CUST-328-09	Komori LS40 Pre-Soaked Felt Seal
	#03.HB.BF.SF13B-01	Komori LS40 Blue Foam Seal
LSX29	#03.HB.PF.CUST-80-09	Komori LSX29 Pre-Soaked Felt Seal
	#03.HB.BF.CUST-79-01	Komori LSX29 Blue Foam Seal
LSX40	#03.HB.PW.CUST-1272-03	Komori LSX40 Pre-Soaked Wool

MITSUBISHI

Harris & Bruno

Diamond 1000	#03.HB.PF.CUST-271-09	Mitsubishi Diamond 1000 Pre-Soaked Felt
	#03.HB.BF.SF9A-01	Mitsubishi Diamond 1000 Blue Foam Seal
Diamond 3000	#03.HB.PF.CUST-106-09	Mitsubishi Diamond 3000 Pre-Soaked Felt
	#03.HB.BF.SF13B-01	Mitsubishi Diamond 3000 Blue Foam Seal
Diamond V3000LX	#03.HB.PF.CUST-106-09	Mitsubishi Diamond 3000 Pre-Soaked Felt
	#03.HB.BF.SF13B-01	Mitsubishi Diamond 3000 Blue Foam Seal
Diamond 4000	#03.HB.PF.CUST-106-09	Mitsubishi Diamond 4000 Pre-Soaked Felt
	#03.HB.BF.SF13B-01	Mitsubishi Diamond 4000 Blue Foam Seal
Diamond 5000	#03.HB.PF.CUST-717-09	Mitsubishi Diamond 5000 Pre-Soaked Felt
	#03.HB.BF.SF13B-01	Mitsubishi Diamond 5000 Blue Foam Seal
Diamond 6000	#03.HB.PF.CUST-144-09	Mitsubishi Diamond 6000 Pre-Soaked Felt
	#03.HB.BF.SF13B-01	Mitsubishi Diamond 6000 Blue Foam Seal

ANILOX COATER END SEALS & GASKETS

RYOBI

PRESS MODEL	PART NUMBER	DESCRIPTION
Harris & Bruno		
520 Series	#03.HB.PF.CUST-599-09	Ryobi 520 Pre-Soaked Felt Seal
	#03.HB.BF.CUST-598-01	Ryobi 520 Blue Foam Seal)
680 Series	#03.HB.PF.CUST-318-09	Ryobi 680 Pre-Soaked Felt Seal
	#03.HB.BF.CUST-317-01	Ryobi 680 Blue Foam Seal
755 Series	#03.HB.PF.CUST-318-09	Ryobi 755 Pre-Soaked Felt Seal
	#03.HB.BF.CUST-317-01	Ryobi 755 Blue Foam Seal
750 Series	#03.HB.PF.CUST-318-09	Ryobi 750 Pre-Soaked Felt Seal
	#03.HB.BF.CUST-317-01	Ryobi 750 Blue Foam Seal

SAKURAI

Harris & Bruno		
Oliver 66SI	#03.HB.PF.CUST-222-01	Sakurai 66 Pre-Soaked Felt Seal
	#03.HB.BF.CUST-222-01	Sakurai 66 Blue Foam Seal
Oliver 66SDP	#03.HB.PF.CUST-953-09	Sakurai 66SDP Pre-Soaked Felt Seal
	#03.HB.BF.CUST-952-01	Sakurai 66SDP Blue Foam Seal

SAKURAI

Harris & Bruno		
Oliver 72	#03.HB.PF.CUST-227-09	Sakurai Oliver 472ED11 Pre-Soaked Felt
	#03.HB.BF.CUST-222-01	Sakurai Oliver 472ED11 Blue Foam Seal
	#03.HB.PF.CUST-227-09	Sakurai Oliver 75SDW Pre-Soaked Felt Seal
Oliver 75SDW	#03.HB.BF.CUST-222-01	Sakurai 75SDW Blue Foam Seal
	#03.HB.PF.CUST-227-09	Sakurai 75 Pre-Soaked Felt Seal
75	#03.HB.BF.CUST-222-01	Sakurai 75 Blue Foam Seal

SHINOHARA

Harris & Bruno		
S52	#03.HB.PF.CUST-398-09	Shinohara 52 Pre-Soaked Felt Seal
	#03.HB.BF.CUST-401-01	Shinohara 52 Blue Foam Seal
S75	#03.HB.PF.CUST-398-09	Shinohara 75 Pre-Soaked Felt Seal
	#03.HB.BF.CUST-401-01	Shinohara 75 Blue Foam Seal
79	#03.HB.PF.CUST-398-09	Shinohara 79 Pre-Soaked Felt Seal
	#03.HB.BF.CUST-401-01	Shinohara 79 Blue Foam Seal

SHEETFED OFFSET ANILOX COATER DOCTOR BLADES



AKIYAMA

Harris & Bruno		
PRESS MODEL	PART NUMBER	DESCRIPTION
Extreme 440	#01.AY.HB.T.E440	UltraFlex 1.125" x .015" x 41.779" Bevel 15° (30 pcs)
	C4139	Onyx 1.125" x .025" x 250' Bevel 22°
	C4045	Polyester 1.25" x .007" x 100' Straight
	C4009	Polyester 1.25" x .015" x 100' Straight
Tresu		
All Models	TDB20S-3000106	Stainless Steel 35mm x .2mm x 91.4m Superhoned
All Models	TDB35P-3000116	Mylar/Polyester 35mm x .37mm x 100m Bevel 15°
Extreme 440	#01.AY.TS.T.E440	UltraFlex 35mm x .37mm x 1062mm Bevel 15° (30 pcs)
Dahlgren		
30"	#01.DG.T.30	UltraFlex 1" x .020" x 30" Bevel 15° (40 pcs)
41.5"	#01.DG.T.41.5	UltraFlex 1" x .020" x 41.5" Bevel 15° (30 pcs)
51"	#01.DG.T.51	UltraFlex 1" x .020" x 51" Bevel 15° (20 pcs.)
52.625"	#01.DG.T.52.625	UltraFlex 1" x .020" x 52.625" Bevel 15° (20 pcs)
60.75"	#01.DG.T.60.75	UltraFlex 1" x .020" x 60.75" Bevel 15° (20 pcs)

HEIDELBERG

Tresu		
All Models	TDB20S-3000106	Stainless Steel 35mm x .2mm x 91.4m Superhoned
All Models	TDB35P-3000116	Mylar/Polyester 35mm x .37mm x 100m Bevel 15°
CD 74	#01.HG.TS.T.CD74	UltraFlex 35mm x .37mm x 786mm Bevel 15° (40 pcs)
SM 74	#01.HG.TS.T.SM74	UltraFlex 35mm x .37mm x 786mm Bevel 15° (40 pcs)
XL75	#01.HG.TS.T.CL75	UltraFlex 35mm x .37mm x 850mm Bevel 15° (40 pcs)
CD 102	#01.HG.TS.T.CD102	UltraFlex 35mm x .37mm x 1065mm Bevel 15° (30 pcs)
SM 102	#01.HG.TS.T.SM102	UltraFlex 35mm x .37mm x 1065mm Bevel 15° (30 pcs)
XL 105	#01.HG.TS.T.XL105	UltraFlex 35mm x .37mm x 1111.25mm Bevel 15° (30 pcs)
XL 145	#01.HG.TS.T.XL145	Ultraflex 35mm x .37mm x 1511.3mm Bevel 15° (20 pcs)

KBA

Harris & Bruno		
Rapida 105	#01.KB.HB.T.RA105	UltraFlex 1.125" x .015" x 43.038" Bevel 15° (30 pcs)
	C4139	Onyx 1.125" x .025" x 250' Bevel 22°
	C4045	Polyester 1.25" x .007" x 100' Straight
	C4009	Polyester 1.25" x .015" x 100' Straight
Rapida 106	#01.KB.HB.T.RA106	UltraFlex 1.125" x .015" x 43.3125" Bevel 15° (30 pcs)
	C4139	Onyx 1.125" x .025" x 250' Bevel 22°
	C4045	Polyester 1.25" x .007" x 100' Straight
	C4009	Polyester 1.25" x .015" x 100' Straight

KBA

Harris & Bruno		
PRESS MODEL	PART NUMBER	DESCRIPTION
Rapida 130	#01.KB.HB.T.RA130	UltraFlex 1.125" x .015" x 57.625" Bevel 15° (20 pcs)
	C4139	Onyx 1.125" x .025" x 250' Bevel 22°
	C4045	Polyester 1.25" x .007" x 100' Straight
	C4009	Polyester 1.25" x .015" x 100' Straight
Rapida 142	#01.KB.HB.T.RA142	UltraFlex 1.125" x .015" x 57.625" Bevel 15° (20 pcs)
	C4139	Onyx 1.125" x .025" x 250' Bevel 22°
	C4045	Polyester 1.25" x .007" x 100' Straight
	C4009	Polyester 1.25" x .015" x 100' Straight
Rapida 162	#01.KB.HB.T.RA162	UltraFlex 1.125" x .015" x 65.475" Bevel 15° (20 pcs)
	C4139	Onyx 1.125" x .025" x 250' Bevel 22°
	C4045	Polyester 1.25" x .007" x 100' Straight
	C4009	Polyester 1.25" x .015" x 100' Straight
Rapida 205	#01.KB.HB.T.RA205	UltraFlex 1.25" x .015" x 82.408" Bevel 15° (30 pcs)
	C4143	Onyx 1.25" x .025" x 250' Bevel 22°
	C4047	Polyester 1.375" x .007" x 100' Straight
	C4017	Polyester 1.375" x .015" x 100' Straight
Tresu		
All Models	TDB20S-3000106	Stainless Steel 35mm x .2mm x 91.4m Superhoned
All Models	TDB35P-3000116	Mylar/Polyester 35mm x .37mm x 100m Bevel 15°
Rapida 104	#01.KB.TS.T.104	UltraFlex 35mm x .37mm x 1089mm Bevel 15° (30 pcs)
Rapida 105	#01.KB.TS.T.RA105	UltraFlex 35mm x .37mm x 1115mm Bevel 15° (30 pcs)
Rapida 106	#01.KB.TS.T.RA106	UltraFlex 35mm x .37mm x 1104mm Bevel 15° (30 pcs)
Rapida 130	#01.KB.TS.T.RA130	UltraFlex 35mm x .37mm x 1464mm Bevel 15° (20 pcs)
Rapida 142	#01.KB.TS.T.RA142	UltraFlex 35mm x .37mm x 1464mm Bevel 15° (20 pcs)
Rapida 162	#01.KB.TS.T.RA162	UltraFlex 35mm x .37mm x 1675mm Bevel 15° (20 pcs)
Rapida 205	#01.KB.TS.T.RA205	UltraFlex 35mm x .37mm x 2094mm Bevel 15° (20 pcs)

KOMORI

Harris & Bruno		
L28	#01.KM.HB.T.L28	UltraFlex 1" x .015" x 29" Bevel 15° (40 pcs)
	C4137	Onyx 1" x .025" x 250' Bevel 22°
	C4037	Polyester 1.125" x .007" x 100' Straight
	C4101	Polyester 1.125" x .015" x 100' Straight
L40	#01.KM.HB.T.L40	UltraFlex 1" x .015" x 41.5" Bevel 15° (30 pcs)
	C4137	Onyx 1" x .025" x 250' Bevel 22°
	C4037	Polyester 1.125" x .007" x 100' Straight
	C4101	Polyester 1.125" x .015" x 100' Straight
LS29	#01.KM.HB.T.LS29	UltraFlex 1.125" x .015" x 31.125" Bevel 15° (30 pcs)
	C4139	Onyx 1.125" x .025" x 250' Bevel 22°
	C4045	Polyester 1.25" x .007" x 100' Straight
	C4009	Polyester 1.25" x .015" x 100' Straight
LS40	#01.KM.HB.T.LS40	UltraFlex 1.125" x .015" x 42.625" Bevel 15° (30 pcs)
	C4139	Onyx 1.125" x .025" x 250' Bevel 22°
	C4045	Polyester 1.25" x .007" x 100' Straight
	C4009	Polyester 1.25" x .015" x 100' Straight
LS44	#01.KM.HB.T.LS44	UltraFlex 1.125" x .015" x 47.625" Bevel 15° (30 pcs)

SHEETFED OFFSET ANILOX COATER DOCTOR BLADES

KOMORI

Harris & Bruno

PRESS MODEL	PART NUMBER	DESCRIPTION
LS44	C4139	Onyx 1.125" x .025" x 250' Bevel 22°
	C4045	Polyester 1.25" x .007" x 100' Straight
	C4009	Polyester 1.25" x .015" x 100' Straight
LSX29	#01.KM.HB.T.LS29	UltraFlex 1.125" x .015" x 31.125" Bevel 15° (30 pcs)
	C4139	Onyx 1.125" x .025" x 250' Bevel 22°
	C4045	Polyester 1.25" x .007" x 100' Straight
	C4009	Polyester 1.25" x .015" x 100' Straight

Tresu

All Models	TDB20S-3000106	Stainless Steel 35mm x .2mm x 91.4m Superhoned
All Models	TDB35P-3000116	Mylar/Polyester 35mm x .37mm x 100m Bevel 15°
L28	#01.KM.TS.T.L28	UltraFlex 35mm x .37mm x 759mm Bevel 15° (40 pcs)
L40	#01.KM.TS.T.L40	UltraFlex 35mm x .37mm x 1039mm Bevel 15° (30 pcs)
LS29	#01.KM.TS.T.LS29	UltraFlex 35mm x .37mm x 860mm Bevel 15° (30 pcs)
LS40	#01.KM.TS.T.LS40	UltraFlex 35mm x .37mm x 1100mm Bevel 15° (30 pcs)
LS44	#01.KM.TS.T.LS44	UltraFlex 35mm x .37mm x 1210mm Bevel 15° (30 pcs)

MANROLAND

Harris & Bruno

800 Series	#01.MR.HB.T.800	UltraFlex 1.25" x .015" x 57" Bevel 15° (20 pcs)
	C4143	Onyx 1.25" x .025" x 250' Bevel 22°
	C4047	Polyester 1.375" x .007" x 100' Straight
	C4017	Polyester 1.375" x .015" x 100' Straight

Tresu

All Models	TDB20S-3000106	Stainless Steel 35mm x .2mm x 91.4m Superhoned
All Models	TDB35P-3000116	Mylar/Polyester 35mm x .37mm x 100m Bevel 15°
500 Series	#01.MR.TS.T.500	UltraFlex 35mm x .37mm x 788mm Bevel 15° (40 pcs)
700 Series	#01.MR.TS.T.700	UltraFlex 35mm x .37mm x 1092mm Bevel 15° (30 pcs)
900 Series	#01.MR.TS.T.900	UltraFlex 35mm x .37mm x 1467mm Bevel 15° (20 pcs)
900 XXL	#01.MR.TS.T.900XXL	UltraFlex 35mm x .37mm x 1986mm Bevel 15° (20 pcs)
906 Series	#01.MR.TS.T.906	UltraFlex 35mm x .37mm x 1477mm Bevel 15° (20 pcs)
900 64 inch	#01.MR.TS.T.900.64	UltraFlex 35mm x .37mm x 1676.4mm Bevel 15° (20 pcs)

MITSUBISHI

Harris & Bruno

Diamond 1000	#01.MB.HB.T.D1000	UltraFlex 1" x .015" x 29.416" Bevel 15° (40 pcs)
	C4137	Onyx 1" x .025" x 250' Bevel 22°
	C4037	Polyester 1.125" x .007" x 100' Straight
	C4101	Polyester 1.125" x .015" x 100' Straight
Diamond 3000	#01.MB.HB.T.D3000	UltraFlex 1.125" x .015" x 41.306" Bevel 15° (30 pcs)
	C4139	Onyx 1.125" x .025" x 250' Bevel 22°
	C4045	Polyester 1.25" x .007" x 100' Straight
	C4009	Polyester 1.25" x .015" x 100' Straight
Diamond 5000	#01.MB.HB.T.D5000	UltraFlex 1.125" x .015" x 52.684" Bevel 15° (30 pcs)
	C4139	Onyx 1.125" x .025" x 250' Bevel 22°
	C4045	Polyester 1.25" x .007" x 100' Straight
	C4009	Polyester 1.25" x .015" x 100' Straight
Diamond 6000	#01.MB.HB.T.D6000	UltraFlex 1.125" x .015" x 58.196" Bevel 15° (30 pcs)
	C4139	Onyx 1.125" x .025" x 250' Bevel 22°
	C4045	Polyester 1.25" x .007" x 100' Straight
	C4009	Polyester 1.25" x .015" x 100' Straight
V3000LX	#01.MB.HB.T.V3000LX	UltraFlex 1.125" x .015" x 42.25" Bevel 15° (30 pcs)
	C4139	Onyx 1.125" x .025" x 250' Bevel 22°
	C4045	Polyester 1.25" x .007" x 100' Straight
	C4009	Polyester 1.25" x .015" x 100' Straight

Tresu

All Models	TDB20S-3000106	Stainless Steel 35mm x .2mm x 91.4m Superhoned
All Models	TDB35P-3000116	Mylar/Polyester 35mm x .37mm x 100m Bevel 15°
Diamond 1000	#01.MB.TS.T.D1000	UltraFlex 35mm x .37mm x 748mm Bevel 15° (40 pcs)
Diamond 3000	#01.MB.TS.T.D3000	UltraFlex 35mm x .37mm x 1050mm Bevel 15° (30 pcs)
Diamond 5000	#01.MB.TS.T.D5000	UltraFlex 35mm x .37mm x 1339mm Bevel 15° (30 pcs)
Diamond 6000	#01.MB.TS.T.D6000	UltraFlex 35mm x .37mm x 1479mm Bevel 15° (30 pcs)

RYOBI

Harris & Bruno

520 Series	#01.RB.HB.T.520S	UltraFlex .75" x .015" x 21.265" Bevel 15° (50 pcs)
	C4134	Onyx .75" x .025" x 250' Bevel 22°
	C4036	Polyester .875" x .007" x 100' Straight
	C4100	Polyester .875" x .015" x 100' Straight
680 Series	#01.RB.HB.T.680S	UltraFlex 1" x .015" x 27.375" Bevel 15° (40 pcs)

RYOBI

Harris & Bruno

PRESS MODEL	PART NUMBER	DESCRIPTION
680 Series	C4137	Onyx 1" x .025" x 250' Bevel 22°
	C4037	Polyester 1.125" x .007" x 100' Straight
	C4101	Polyester 1.125" x .015" x 100' Straight
755 Series	#01.RB.HB.T.755S	UltraFlex 1" x .015" x 30.912" Bevel 15° (40 pcs)
	C4137	Onyx 1" x .025" x 250' Bevel 22°
	C4037	Polyester 1.125" x .007" x 100' Straight
	C4101	Polyester 1.125" x .015" x 100' Straight
750 Series	#01.RB.HB.T.750S	UltraFlex 1" x .015" x 31.642" Bevel 15° (40 pcs)
	C4137	Onyx 1" x .025" x 250' Bevel 22°
	C4037	Polyester 1.125" x .007" x 100' Straight
	C4101	Polyester 1.125" x .015" x 100' Straight

MMT

520	#01.RB.MM.T.520	UltraFlex 1" x .020" x 21.625" Bevel 15° (40 pcs)
755	#01.RB.MM.T.755	UltraFlex 1" x .020" x 31.125" Bevel 15° (30 pcs)

Tresu

All Models	TDB20S-3000106	Stainless Steel 35mm x .2mm x 91.4m Superhoned
All Models	TDB35P-3000116	Mylar/Polyester 35mm x .37mm x 100m Bevel 15°
520 Series	#01.RB.TS.T.520S	UltraFlex 35mm x .37mm x 541mm Bevel 15° (50 pcs)
680 Series	#01.RB.TS.T.680S	UltraFlex 35mm x .37mm x 696mm Bevel 15° (40 pcs)
755 Series	#01.RB.TS.T.755S	UltraFlex 35mm x .37mm x 807mm Bevel 15° (40 pcs)
750 Series	#01.RB.TS.T.750S	UltraFlex 35mm x .37mm x 804mm Bevel 15° (40 pcs)

SAKURAI

Harris & Bruno

Oliver 66SI	#01.SK.HB.T.OL66SI	UltraFlex 1" x .015" x 27.369" Bevel 15° (40 pcs)
	C4137	Onyx 1" x .025" x 250' Bevel 22°
	C4037	Polyester 1.125" x .007" x 100' Straight
Oliver 66SD	#01.SK.HB.T.OL66SD	UltraFlex 1" x .015" x 27.763" Bevel 15° (40 pcs)
	C4137	Onyx 1" x .025" x 250' Bevel 22°
	C4037	Polyester 1.125" x .007" x 100' Straight
Oliver 72	#01.SK.HB.T.OL72	UltraFlex 1" x .015" x 29.259" Bevel 15° (40 pcs)
	C4137	Onyx 1" x .025" x 250' Bevel 22°
	C4037	Polyester 1.125" x .007" x 100' Straight
Oliver 75SD	#01.SK.HB.T.OL75SD	UltraFlex 1" x .015" x 31.897" Bevel 15° (40 pcs)
	C4137	Onyx 1" x .025" x 250' Bevel 22°
	C4037	Polyester 1.125" x .007" x 100' Straight
Oliver 75SD	#01.SK.HB.T.OL75SD	UltraFlex 1" x .015" x 31.897" Bevel 15° (40 pcs)
	C4137	Onyx 1" x .025" x 250' Bevel 22°
	C4037	Polyester 1.125" x .007" x 100' Straight

Tresu

All Models	TDB20S-3000106	Stainless Steel 35mm x .2mm x 91.4m Superhoned
All Models	TDB35P-3000116	Mylar/Polyester 35mm x .37mm x 100m Bevel 15°
Oliver 66SI	#01.SK.TS.T.OL66SI	UltraFlex 35mm x .37mm x 696mm Bevel 15° (40 pcs)
Oliver 66SD	#01.SK.TS.T.OL66SD	UltraFlex 35mm x .37mm x 706mm Bevel 15° (40 pcs)
Oliver 72	#01.SK.TS.T.OL72	UltraFlex 35mm x .37mm x 744mm Bevel 15° (40 pcs)
Oliver 75SD	#01.SK.TS.T.OL75SD	UltraFlex 35mm x .37mm x 811mm Bevel 15° (40 pcs)

SHINOHARA

Harris & Bruno

S52	#01.SH.HB.T.S52	UltraFlex 1" x .015" x 21.857" Bevel 15° (40 pcs)
	C4137	Onyx 1" x .025" x 250' Bevel 22°
	C4037	Polyester 1.125" x .007" x 100' Straight
S75	#01.SH.HB.T.S75	UltraFlex 1" x .015" x 30.912" Bevel 15° (40 pcs)
	C4137	Onyx 1" x .025" x 250' Bevel 22°
	C4037	Polyester 1.125" x .007" x 100' Straight
79	#01.SH.HB.T.79	UltraFlex 1" x .015" x 32.487" Bevel 15° (40 pcs)
	C4137	Onyx 1" x .025" x 250' Bevel 22°
	C4037	Polyester 1.125" x .007" x 100' Straight
79	#01.SH.HB.T.79	UltraFlex 1" x .015" x 32.487" Bevel 15° (40 pcs)
	C4137	Onyx 1" x .025" x 250' Bevel 22°
	C4037	Polyester 1.125" x .007" x 100' Straight

Tresu

All Models	TDB20S-3000106	Stainless Steel 35mm x .2mm x 91.4m Superhoned
All Models	TDB35P-3000116	Mylar/Polyester 35mm x .37mm x 100m Bevel 15°
S52	#01.SH.TS.T.S52	UltraFlex 35mm x .37mm x 556mm Bevel 15° (40 pcs)
S75	#01.SH.TS.T.S75	UltraFlex 35mm x .37mm x 786mm Bevel 15° (40 pcs)
79	#01.SH.TS.T.79	UltraFlex 35mm x .37mm x 826mm Bevel 15° (40 pcs)

KEYLESS OFFSET BLADES

KBA

PRESS MODEL	PART NUMBER	DESCRIPTION
Genius 52	#01.KB.S.GENIUS52	Steel 20mm x .2mm x 563mm Beveled (50 pcs) (KBA# 1001-2618)
Karat 74	#01.KB.S.KARAT74	Steel 28mm x .2mm x 787.4mm Beveled (50 pcs) (KBA# P1582210)
Metronic	#01.KB.S.METRON	Steel .875" x .008" x 6.875" Superhoned (100 pcs)

KBA

PRESS MODEL	PART NUMBER	DESCRIPTION
RA74 Gravuflex	#01.KB.T.RA74G	UltraFlex 27mm x .37mm x 765mm B15 (50 pcs)

HEIDELBERG

PRESS MODEL	PART NUMBER	DESCRIPTION
SM 52 Anicolor	#01.HG.S.SM52A	Gold Steel 30mm x .15mm x 560mm Beveled (20 pcs)

WASH-UP BLADES

Wash-up blades for all presses, in stock and ready for delivery.

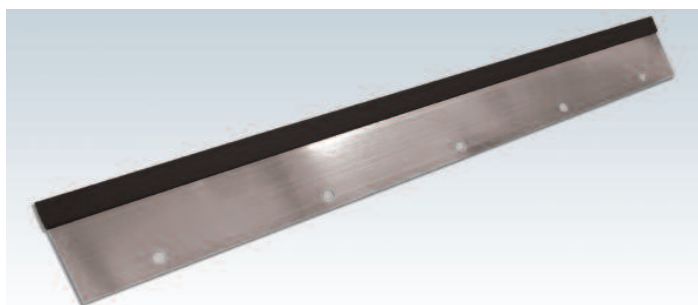

Komori

PART #	PRESS	TYPE	SIZE	HOLES
WB1490-96M/R	C-18	Metal Rubber	2 1/8" x 21 1/4"	6 holes
WB1490-72M/R	L20,420 Lithrone	Metal Rubber	1.41" x 23 3/8"	5 holes
WB1500-2M/R	Super Sprint L225,426	Metal Rubber	1 3/4" x 27.9"	6 holes
WB1500-12M/R	LB425 Sprint New Type	Metal Rubber	1 3/4" x 28 3/8"	6 holes
WB1500-32M/R	Super Sprint 83' to 86' L425 BP	Metal Rubber	1.97" x 28 1/2"	6 holes
WB1500-44M/R	Lithrone Sprint New Model	Metal Rubber	1 3/8" x 28 3/8"	6 holes
WB1490-87U	L-526	Urethane	1.85" x 27 1/8"	10 holes
WB1490-89/MR	L-526	Metal Rubber	1.85" x 27 1/8"	10 holes
WB1520-35M/R	New Automatic Blanket Washer	Metal Rubber	1 1/8" x 27 1/8"	12 slots
WB1500-44T/U	Lithrone 26	3/8" Thick Urethane	1 3/8" x 28 3/8"	6 holes
WB1495-23T/U	Lithrone 26	1/4" Thick Urethane	1 3/8" x 28 3/8"	6 holes
WB1550-32T/P	Lithrone 26	3/8" Thick Plastic	1 3/8" x 28 3/8"	6 holes
WB1520-34M/R	New Auto Washer Lithrone 28	Metal Rubber	1 1/8" x 30 3/8"	13 slots
WB1490-71M/R	Sprint Lithrone 28	Metal Rubber	1.46" x 30 3/8"	6 holes
WB1495-2G/U	Sprint Lithrone 28	Green Urethane	1.87" x 30"	11 holes
WB1490-66M/R	Komori 38	Metal Rubber	2 3/8" x 41 3/8"	11 holes
WB1410-101M/R	Komori 38	Metal Rubber	2" x 41 3/8"	9 holes
WB1410-85R	Lithrone 40	Rubber	2" x 42 1/8"	8 holes
WB1410-935S/P	Lithrone 40	Solid Plastic	2" x 42 1/8"	8 holes
WB1410-945S/P	Lithrone 40	Solid Plastic	1.8" x 42 1/8"	8 holes
WB1410-84M/R	Lithrone 40	Metal Rubber	2" x 42 1/8"	8 holes
WB1410-102M/R	Lithrone 40	Metal Rubber	2" x 42 1/8"	7 holes
WB1410-103M/R	Lithrone 40	Metal Rubber	2" x 42 1/8"	8 holes
WB1490-75M/R	Lithrone 40	Metal Rubber	1.94" x 42.4"	15 holes
WB1410-104P	Lithrone 40	Plastic	2" x 42 1/8"	15 holes
WB1410-107M/R	Lithrone 40	Metal Rubber	2" x 42 1/8"	15 holes
WB1410-108G/U	Lithrone 40	Green Urethane	2" x 42 1/8"	15 holes
WB1410-93A/U	Lithrone 40	Amber Urethane	2" x 42 1/8"	15 holes
WB1495-7M/R	Lithrone 44	Metal Rubber	2" x 47"	17 holes
WB1410-106S/P	Lithrone 44	Solid Plastic	2" x 47"	17 holes
WB1490-95G/U	Lithrone 50	Green Urethane	2" x 54"	19 holes

Specialty Blades Made To Order

Ask your representative for complete details.

Mitsubishi

PART #	PRESS	TYPE	SIZE	HOLES
WB1410-95	38 L 750	Metal Rubber	2" x 41 1/4"	11 holes
WB1490-65	36 XL750	Metal Rubber	1 3/4" x 39"	11 holes
WB1520-6	40 3 E	Solid Rubber	1 3/4" x 44"	11 slots
WB1520-10	28 1 E	Original Rubber	1.55" x 30 3/8"	8 slots
WB1520-10	28 1 E	Special Plastic	1.55" x 30 3/8"	8 slots
WB1520-13	40 3 E	Plastic Original	1 3/4" x 42 3/8"	11 slots
WB1520-20	40 6 E Plastic 3 F Manual Wash	Metal Rubber	1 3/8" x 42 1/2"	11 slots
WB1520-20 40	3 F Auto Wash	Solid Rubber	1 3/8" x 42 1/2"	11 slots
WB1520-21	28 1	Metal Rubber	1.115" x 30 3/8"	9 slots
WB1520-21	28 1 F	Solid Plastic	1.45" x 30 3/8"	9 slots
WB1520-22	51 5 F	Solid Rubber	1 3/8" x 53 3/4"	13 slots
WB1520-24	40 3 F Auto Wash	Solid Rubber	1.611" x 42 1/2"	11 slots
WB1520-26	40 3 E	Solid Rubber	1 3/4" x 43 3/8"	11 slots
WB1520-27	28 1 F	Solid Rubber	1.115" x 30 3/8"	9 slots
WB1520-42	51 5 FH	Metal Urethane		11 slots
WB1520-43	40 3 FH	Metal Rubber	1.575" x 43.23"	11 slots



Heidelberg

PART #	PRESS	SIZE	HOLES
WB1540-5	T-OFFSET	1.69 X 11.1875	4
WB1290-2	GTO 46	2.375 X 19.734	5
WB1290-3	GTO 52	2.375 X 22	6
WB1280-1	KOR & KORA	1.975 X 23.5625	10
WB1285-7	KORD 62	1.975 X 25.5625	10
WB1285-4	KORD 64	1.975 X 27.156	12
WB1285-3	KORS	1.975 X 29.906	12
WB1285-5	SORK (old style)	2 x 28 3/8	12
WB1290-4	SORK-Z / MO	2 3/8 X 28 3/16	8
WB1300-3	SORM-Z / SM72	1.575 X 29.687	9
WB1280-7	SORDZ (old)	1.97 X 37.781	12
WB1290-5	SORDZ (new)	2.375 X 37.8125	10
WB1290-18	SPEEDMASTER 52	1.85 X 23.8125	7
WB1300-9	SPEEDMASTER 74	2.25 X 32.5	9
WB1300-1	SPEEDMASTER 102	2.35 X 42.9375	11
WB1290-14	SM 102 BLANKET UNIT	2.25 X 41	11
WB1300-14	SM 102 CD	2.24 X 42.9375	11
WB1300-2	SM 102	1.575 X 41.4375	11
WB1300-4	SM 102 BLANKET UNIT	2.375 X 41.4375	11
WB1300-6	SM 102 CD	2.25 X 42.875	11

CLEAN UP MATS



Press Clean Up Sheets

RGS Clean Up Sheets are for trouble-free press roller clean up. Two-ply highly absorbent (packaged in hundred sheet boxes).

MODEL	STYLE	SIZE	PART#
-------	-------	------	-------

A.B. Dick

330, 331	Pin Bar	15 1/8" x 18 9/16"	CM151818916PB
350, 320	Slotted	10 1/8" x 15 5/8"	CM1015SLOT
350, 320	Pin Bar	10 1/8" x 15 1/8"	CM1015PB
350, 320	Str Edge	10 5/32" x 15 1/16"	CM1053215116SE
360, 367	Pin Bar	11 1/16" x 18 5/8"	CM111858PB
375	Pin Bar	13" x 18 5/8"	CM13018PB
380	Str Edge	15 5/8" x 20 5/8"	CM15582058SE
385 NEW	Str Edge	19 3/8" x 22 7/8"	CM1922SE
382 OLD	Str Edge	19 3/8" x 22 3/4"	CM19382234SE
9800 Series	Pin Bar	13" x 19 3/8"	CM131938PB

ATF

15	Slotted	10 1/8" x 15 5/8"	CM1015SLOT
15	Pin Bar	10 1/8" x 15 5/8"	CM101558PB
17	Pin Bar	11 1/8" x 18 1/8"	CM11181818PB
217	Pin Bar	11" x 18"	CM1118
2000	Pin Bar	12 7/8" x 18"	CM127818PB
2117	Pin Bar	13" x 18 1/16"	CM1318116PB
SUPER-CHF SPC	Pin Bar	12 3/4" x 18"	CM123418PB
2217 SUPER CHIEF	Pin Bar	13 1/8" x 18"	CM131818PB
14 x 20	Str Edge	15 3/8" x 20 3/4"	CM15382034SE

Davidson

221, 241, 251	Str Edge	10 1/8" x 16 1/8"	CM10181618SE
400, 500	Str Edge	10 1/8" x 16 1/8"	CM10181618SE
DAV-A-MATIC	Str Edge	14 1/2" x 13 1/8"	CM14121318SE
233, 700	Str Edge	16" x 17 5/8"	CM1617SE
600, 601	Str Edge	13 3/4" x 17 5/8"	CM13341758SE
901	Str Edge	13 3/4" x 17 5/8"	CM13341758SE

Gestetner

313	Pin Bar	13" x 18 3/16"	CM1318316PB
-----	---------	----------------	-------------

Hamada

500	Pin Bar	11 7/8" x 15 1/4"	CM11781514PB
500	Slotted	10 13/16" x 15 3/16"	CM1015316SLOT
500 CDA	Pin Bar	12 1/2" x 15 1/2"	CM1215PB
600	Pin Bar	12" x 18 1/4"	CM121814PB
611/612	Pin Bar	12 1/8" x 18 3/16"	CM1218PB
700	Pin Bar	15 1/2" x 18 1/2"	CM1518PB
700	Slotted	15 1/2" x 18 1/2"	CM1518SLOT

MODEL	STYLE	SIZE	PART#
800-17 holes	Slotted	15 1/2" x 20 1/2"	CM15122012SLOT
800-18 holes	Slotted	15 1/2" x 20 5/8"	CM15122058SLOT

Heidelberg

TOK	Slotted	10 3/4" x 181 13/16"	CM1034181316SLOT
-----	---------	----------------------	------------------

ITEK

950	Slotted	10 5/8" x 15 1/2"	CM10581512SLOT
960	Pin Bar	11 5/16" x 185/8"	CM115161858PB
975	Pin Bar	13" x 18 1/2"	CM1318PB
985	Pin Bar	13 5/8" x 195/8"	CM13581958PB

Miehle

MGD	Slotted	15 1/2" x 201/2"	CM15122012SLOT
MIEHLE 17	Pin Bar	14 1/2" x 18 1/2" MET	CM14121812PB

Multiliths

1250	Slotted	10 1/8" x 15 5/8"	CM1015SLOT
1250, 2550	Pin Bar	10 1/8" x 15 1/8"	CM1015PB
1250	Serrated	10 1/8" x 15 3/8"	CM10181538SER
1250	Str Edge	10 5/32" x 15 1/16"	CM105321516SE
1250 WIDE	Pin Bar	11 1/8" x 15 1/8"	CM1115PB
1251 WIDE	Slotted	11 1/16" x 15 5/8"	CM11161558SLOT
1252 WIDE	Str Edge	10 1/16" x 15 5/8"	CM101161558SE
1250 W	Pin Bar	11 1/8" x 18 1/8"	CM11181818
1250 LW	Pin Bar	11 1/8" x 18 1/8"	CM11181818
1360	Pin Bar	12 3/4" x 18 1/8"	CM121818PB
1360	Pin Bar	12 7/8" x 15"	CM127815PB
1650	Pin Bar	12 3/4" x 18"	CM123418PB
1650 XE	Pin Bar	12 3/4" x 18 1/8"	CM121818PB
1850	Pin Bar	15 1/8" x 18 1/8"	CM15181818PB

Rotoprint

R30/95	Pin Bar	14 1/2" x 18"	CM141218PB
R30	Pin Bar	14 9/16" x 8 1/8"	CM14916818PB
R38-50	Pin Bar	19 3/4" x 16 3/4"	CM19341634PB

Ryobi

480	Pin Bar	16" x 19"	CM1619PB
480 K	Slotted	16 1/16" x 19"	CM1611619SLOT
500 N	Str Edge	16" x 19 1/2"	CM161912SE
480/500N	Slotted	16 1/8" x 19"	CM161819SLOT
2700	Str Edge	10 5/8" x 15 1/2"	CM10581512SE
2700	Slotted	11" x 15 1/2"	CM111512SLOT
2800	Pin Bar	11 7/16" x 18 5/8"	CM1171618PB
2800 CD-XL	Pin Bar	11 1/4" x 19 3/8"	CM11141938PB
2800 XL	Pin Bar	11 3/8" x 19 3/8"	CM1119PB
3200	Pin Bar	12 3/4" x 18 5/8"	CM121858PB
3200 MCD	Pin Bar	13 5/8" x 19 3/8"	CM13581938PB
3985	S.E.	14" x 19 3/32"	CM1419SE

Toko

4700	Pin Bar	13 17/32" x 18 5/8"	CM131858PB
4750	Pin Bar	13" x 19 3/8"	CM131938PB

Hickey Removers

Our hickey removers are designed and manufactured to original specifications. We use the highest quality raw materials including corrosion-proof steel and chemical resistant rubber. The molded rubber tips are chemically bonded to the steel preventing separation.

Heidelberg



Model: Speedmaster 102 and SM72 with ALCOLOR
Description: Complete assembly. Made of steel with a handle of lacquered hard wood ensuring long life in production.
Packing: 1 piece
Part# 2HR102CPL 93.205.516/B



Model: Speedmaster 52 / 74CD
Description: Complete assembly. Made of steel with rubber tip molded and chemically bonded on.
Packing: 1 piece
Part# 2HRSM52 G2.207.001



Model: Speedmaster 74
Description: Complete assembly. Made of steel with rubber tip molded and chemically bonded on.
Packing: 1 piece
Part# 2HR74 M2.033.0615/03



Model: SORS, SORD, SORM, MO, SM72 w/standard dampening
Description: Complete assembly. Made of lacquered hard wood with hickey remover wedged in and fastened in place. Includes steel plate/screws for positioning on press.
Packing: 1 piece
Part# 2HRSO/MO 93.024.025F/F
43.024.025F/02A



Model: Speedmaster 74 - Complete Assembly
Part# HR74



Model: Speedmaster 52 - Complete Assembly
Part# HRSM52



Model: Speedmaster 105 - Complete Assembly
Part# HR105

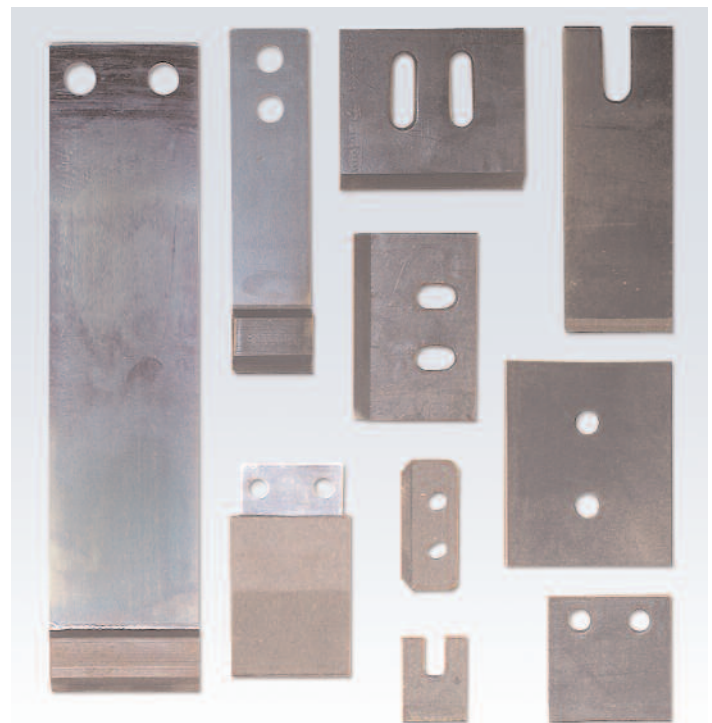

Hickey Picker Replacement Tips

Replacement Tips for Hickey Picker Handles

PRESS	PART #
Miller	HP1660-1
Komori (hard rubber thick metal)	HP1660-2
Akiyama (rubber)	HP1660-3
Miehle	HP1660-4
Akiyama (urethane)	HP1660-5
Heidelberg (spdmstr)	HP1660-6
Heidelberg (met/rub)	HP1660-7
Special (met/rub)	HP1660-8
Planeta (40")	HP1660-9
Shinohara 52	HP1660-10
Special (1" x 4")	HP1660-11
Planeta 40 (urethane)	HP1660-12
Komori (wide)	HP1660-13
Special	HP1660-14
Mitsubishi (waterless)	HP1660-15
Heidelberg (met/rub Special)	HP1660-16
Special	HP1660-17
Planeta 50 (urethane)	HP1660-18
Mitsubishi (black rubber)	HP1660-19
Shinohara (white silicone, waterless)	HP1660-20
Shinohara (urethane/brass)	HP1660-21
Komori (soft thick waterless)	HP1660-22
Komori (hard rubber, thin metal)	HP1660-23
Mitsubishi (black rubber like HP1660-15)	HP1660-24
Sakurai (2 hole)	HP1660-25
Roland 800 (4 hole)	HP1660-26
Komori (wide, thin metal)	HP1660-27
KBA Planeta	HP1660-28
Heidelberg MO (one slot)	HP1660-29
Special (waterless)	HP1660-30
Heidelberg MO (no holes)	HP1660-31
Heidelberg MO (two holes)	HP1660-32

Air Filters

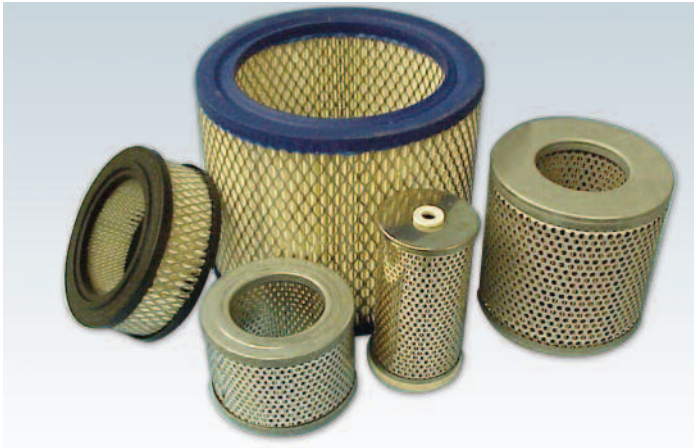

Becker Pump

MODEL #	QTY	RGS #	BECKER #
DVP, VP,DP-25 & 40	2	FC75/2	909505
DVP, VP,VP-60 & 70	2	FC912	909506
DVP, VP,DP-100 & 140	2	FC1112/2	909507
VT-3.25	1	FC76/2	9095211
		FC44	909518
DVT-2.100	1	FC1112/2	909507
DVT-2.80	1	FC75/2	909505
	1	FC713	909510
DVT-2.140	1	FC1112/2	909507
	1	FC75/2	9095051
		FC718	909514
DVT-3.80	1	FC1112/2	909507
	1	FC912	909506
	1	FC713	909510
KVT-2.100	1	FC1112/2	909507
	1	FC75/2	909505
	1	FC713	909510
KVT-2.140	1	FC1112/2	909507
	1	FC75/2	909505
	1	FC718	909514
KVT-2.80	1	FC1112/2	909507
	1	FC713	909510

Werie Model

MODEL #	QTY	RGS #	WERIE #
CL-60-DV	1	FC31/1	730501
	2	FC42/1	730504
	2	FC64/1	730506
CL-40-DVVL &	2	FC31/1	730501
CL-60-DVVL	3	FC64/1	730506
CLFT-40-DV	2	FC32	730502
	2	FC43	730505
CLFT-60-DV	2	FC32	730502
	2	FC66	730507
CLFT-80-DV	2	FC43	730505
	2	FC66	730507
CLFT-100-DV	1	FC32	730502
	2	FC43	730505
	3	FC66	730507

MODEL #	QTY	RGS #	WERIE #
CLFT-41-DV	2	FC32	730502
	2	FC43	730505
	2	FC66/1	730524
CLFT-61-DV	2	FC32	730502
	2	FC66	730507
	2	FC66/1	730524
CLFT-81-DV	2	FC43	730505
	2	FC66	730507
	2	FC66/1	730524
CLFT-101-DV &	1	FC32	730502
CLFT-141-DV	2	FC43	730505
	3	FC66	730507
	3	FC66/1	730524
TR-10-DV	2	FC42/1	730504
	1		513457
TR-15-DV	2	FC64/1	730506
	1		513457
TR-25-DV	1	FC42/1	730504
	1	FC64/1	730506
	1		515339
TR-40-DV	2	FC66/1	730524
	1		515340
	1	FC610/2	515310
TR-60-DV(V)	2	FC79/1	730508
	1	FC69/1	515411
TR-80-DV(V)	2	FC79/1	730508
CLFG-41-V	2	FC64/1	730506
DCL(F)-40-DV	2	FC32	730502
	1	FC66	730507
DCL(F)-60-DV	4	FC32	730502
	1	FC66	730507
DCL(F)-60-DVVL	2	FC66	730507
	4	FC32	730502
DCL(F)-80-DV &	2	FC32	730502
DCL(F)-80-DVVL	2	FC43	730505
	2	FC66	730507
DCL(F)-100-DV	2	FC43	730505
	1	FC66	730507
	2	FC79/1	730508
DCL(F)-130-DV &	2	FC43	730505
DCL(F)-130-DVVL(S)	4	FC79/1	730508
DCL-198-DV	1	FC43	730505
	2	FC79/1	730508
	3	FC711/1	730511
DCL(F)-200-DV	2	FC43	730505
	1	FC66	730507
	3	FC711/1	730511
CL-25-DV	7	FC31/1	730501
CL-40-DV	1	FC31/1	730501
	2	FC42/1	730504
	2	FC64/1	730506
KTA-140/1	4	FC713/1	731142
KTA 100	1	FC717/1	731143

Air Filter Reference Guide

RGS #	I.D.	O.D.	HEIGHT	FEATURES
FC31	7/16	1-3/16	1-7/32	COEB
FC31/1	7/16	1-3/16	1-15/32	COEB
FC32	7/16	1-3/16	2-1/2	COEB
FC42/1	0.5	1-1/2	1-15/32	COEB
FC44	0.5	1-1/2	1-15/32	COE
FC43	0.5	1-1/2	2-1/2	COEB
FC54	0.5	1-1/2	5"	COEB
FC64/1	11/16	2-5/16	1-15/32	COEB
FC64/3	11/16	2-5/16	1-15/32	COE
FC66/1	11/16	2-5/16	2-1/32	COEB
FC66	11/16	2-5/16	2-1/2	COEB
FFP70T	27/32	1-3/4	3-1/4	COEB, 2G
FFP100T	27/32	1-3/4	4-13/16	COEB, 2G
FC79/1	1"	2-1/2	2-27/32	COEB
FC711	1"	2-9/16	4-1/2	COEB, 2G
FC74	1-1/16	2-5/8	1-1/16	STD, 3G
FC78/2	1-1/16	2-5/8	2-3/16	STD, 3G
FC69/1	1-7/32	2"	5-5/8	COEB, G
FC610/2	1-7/32	2"	6-3/8	COEB, G
FC76/2	1-1/2	2-1/2	1-3/4	COE
FC78/6	1-1/2	2-1/2	2-1/4	COE, G
FC79/2	1-1/2	2-1/2	2-11/16	COE, G
FC75/2	1-1/2	2-1/2	2-11/16	COE, G
FC718/1	1-1/2	2-1/2	6-1/4	COE, 3G, S
FC713	1-1/2	2-9/16	4-1/2	COEB, 2G
FC718	1-1/2	2-9/16	6-7/16	COEB, 1G
FC711/1	1-1/2	2-5/8	2-3/4	COE
FC1049	1-13/16	3-1/2	5-3/4	STD
FFPC100BW	1-27/32	3-1/4	2-3/8	Molded
FC912	2-3/8	3-5/16	2-3/4	COE, G
FC1112	2-3/8	3-7/8	2-13/16	STD
FC1132	2-3/8	3-7/8	3-15/16	STD
FC1112/2	2-1/2	3-7/8	2-3/4	COEB, 2G
FC1337	2-9/16	5"	4-13/16	STD
FC15124/1	3-1/2	5-7/8	8-3/4	STD, 2G
FC24355	5-1/4	9-1/2	8-5/8	COE, G

Main Air Filters for Heidelberg Presses

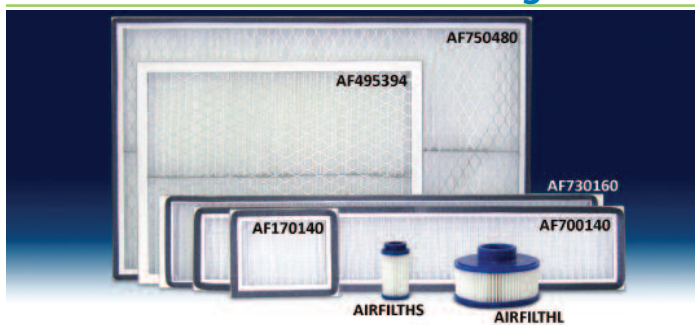

PART #	DESCRIPTION
AF750480	750 X 480 X 47mm
AF495394	495 X 394 X 47mm
AF730160	730 X 160 X 47mm
AF700140	700 X 140 X 47mm
AF170140	170 X 140 X 47mm
AIRFILTHL	128.5 X 44 X 84mm
AIRFILTHS	43 X 20 X 89mm



Water Filters

RGS #	DESCRIPTION
FF1006	Baldwin Foam Filter 4 1/4 I.D. x 8 3/4 x 3/4
FF1007	Baldwin Foam Filter 6 I.D. x 11 1/2 x 1
FF1008	U-Filters 7" x 15" U Shape 6.50
FF1009	Baldwin Flat Filters 7 1/8 x 7 1/8 x 1/2
FF1010	Royse Foam Filters 5 I.D. x 7 1/8 x 7/8
FF1011	Dahlgreen & Halm, Flat Filter 7 1/8 x 13 1/2 x 7/8
FF1012	Foam Filter 10 x 12 (Black)
FF1013	Box Foam Filter 8" x 10"
FF1017	Royse Foam Filter 7 1/2 x 14 1/2 x 3/4
FF1019	Foam Filter (8" Tall) 4 1/4 x 8 x 3/4
FF1030	Foam Filters 7 1/2 x 12 1/4 x 1
FF1039	Diffusion Pads 3 1/2 D
FF1049	Foam Filter 7 1/2 x 11 1/2
FF1051	Foam Filter 8 x 10 5/8
FF1058	Techotrans Filter 16 1/2 x 16 1/2 x 1
FF1085	Felt Filter 15 1/4" x 22 1/2"
FF1090	Poly Filter 12 x 12 x 1
FF1106	Foam Filter 14 1/2 x 8 3/4 x 3/4
FF1115-1	Baldwin Flat Filter 16 x 12 x 3/4
FF1117	Foam Filter 7 1/4 x 11 1/4
FF1130000301	Royse Air Filter w/frame 10 3/4 x 15 x 1/2"
FF1131-1	Poly Filter 7 3/4 x 12 3/4 x 1/2
FF1131-2	Techotrans Filter 9 x 7 1/2 x 1/2
FF1132	Baldwin Filter Foam 8 x 13
FF1134	Foam Filter 12 3/4 x 7 3/4
FF1139	Baldwin Filter 12 x 18 x 1/2
FF1140	Filter 8 x 12 1/2 x 1"
FF1141	Baldwin Filter 6 x 18
FF114	Technotronic Filter 10" x 18 1/2" x 1/2"
FF1148-1	Techotrans Filter 9 1/2 x 17 1/2 x 1/2
FF1155	Foam Filter Man Roland 10 x 18 1/2 x 3/4
FF1162	Foam Filters 9 1/4 x 11 1/4
FF1163	Foam Filter 6 x 18
FF1172	Technotronic Filter 10" x 12"
FF1182	Foam Filter 10 x 12
FF1192	Poly Filter 8 x 14 x 3/4 (Baldwin)
FF1193	Foam Filter 10 x 12 1/4
FF512	Filter 5" x 12 1/4" x 3/4"
FF712	Foam Filter 7 3/4 x 12 3/8 x 1
FF911	Foam Filters 9 1/2 x 11 x 3/4
FF1151	Poly Filter 9 1/2 x 9 1/2 x 1/2
FF1178-1	Filter 10 1/2 x 25 1/2 x 1/2 Poly
FF1178-2	Filter Poly 11 x 26 x 1/2
FF1181-2	Techotrans Filter 9 1/2 x 18
FF1133	Poly Filter 6 x 18 1/2 x 1
FF7600EAE	Fountain Pure Filters
FF7602EAE	Fountain Pure Filter LSW (Large) 1"



Rietschle Silencers

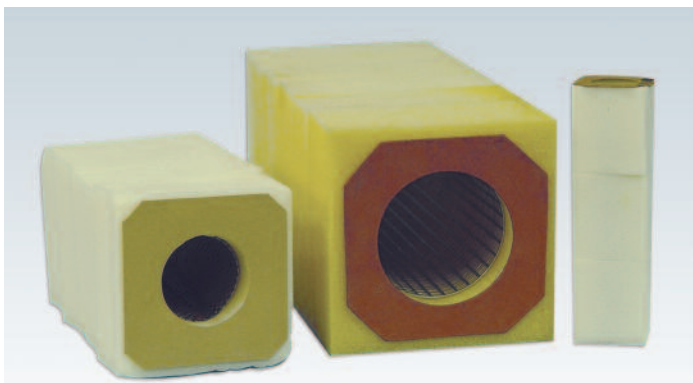

RGS #	O.D.	I.D.	O.A.L.	SCREEN
F307436	2-1/2"	1"	5-1/4"	NO
F307437	2-1/2"	1"	5-1/4"	YES
F315541	2-1/2"	1"	8-3/4"	YES
F315542	2-1/2"	1"	8-3/4"	NO
F307438	2-1/2"	1-5/8"	5-1/4"	NO
F307439	2-1/2"	1-5/8"	5-1/4"	YES
F315606	2-1/2"	1-5/8"	8-3/4"	YES
F307440	3-1/4"	1-1/2"	7"	NO
F307441	3-1/4"	1-1/2"	7"	YES
F307434	1-3/8"	1"	4-11/16"	NO
F307435	1-3/8"	1"	4-11/16"	YES
F315193	1-3/8"	1"	1-9/16"	NO
F315448	1-3/8"	1"	6-1/4"	NO
F315449	1-3/8"	1"	6-1/4"	YES
F307446	4-3/8"	2-5/8"	8-3/4"	NO
F307447	4-3/8"	2-5/8"	8-3/4"	YES
F314632	4-3/8"	2-5/8"	10-1/2"	NO
F314633	4-3/8"	2-5/8"	10-1/2"	YES
F307448	5-1/4"	4"	14"	NO
F307449	5-1/4"	4"	14"	YES
F314666	5-1/4"	4"	16"	YES
F314667	5-1/4"	4"	16"	NO
F307444	3-3/4"	2-3/8"	7-13/16"	NO
F307445	3-3/4"	2-3/8"	7-13/16"	YES
F315660	3-3/4"	2-3/8"	9-3/8"	NO
F315661	3-3/4"	2-3/8"	9-3/8"	YES
F307442	3.30"	1.95"	7"	NO
F307443	3.30"	1.95"	7"	YES
F317000	3.30"	1.95"	8-3/4"	NO
F317001	3.30"	1.95"	8-3/4"	YES
F315049	1.96"	.78"	2.36"	NO

Main Oil Filters for Heidelberg

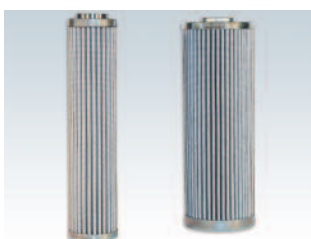

Main oil filters for Speedmasters.

Part#

FV30520-06
FV30720-06

Replacement Foam Filters

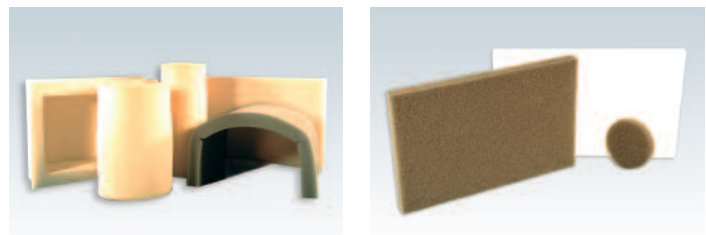

Available for Baldwin, Dahlgren and Royse circulation systems

RGS #	DESCRIPTION
FF1006	4 1/4" OD x 8 1/2" Baldwin Round
FF1007	6" OD X 11 1/2" Baldwin Round
FF1008	6 3/4" x 15 1/2" Baldwin U-Shaped
FF1009	7 1/8" x 7 1/8" Baldwin Flat
FF1010	5" OD x 7 1/8" Dahlgren Round
FF1011	7 1/8" x 13 1/2" Dahlgren & Halm, Flat
FF1012	10 1/2" x 12 1/2" Baldwin Newspapers
FF1013	10 1/2" x 7 3/4" x 3 3/4" Baldwin Box Type
FF1017	7 1/2" x 14 1/2" Royse Flat
FF1019	4 1/4" O.D x 8" Baldwin Round
FF1024	3" OD x 10 5/8" Smith RPM
FF1033	5" x 20" Bag Filter- Herbert
FF1037	15 1/2" x 24" Bag Filter-Herbert
FF1039	3 3/8" Dia. Royse Diffusion Pad

Air Filters for Heidelberg



Air filter for Heidelberg - Large
Part# AIRFILTHL

Air filter for Heidelberg - Small
Part# AIRFILTHS

Oil Filters for Komori

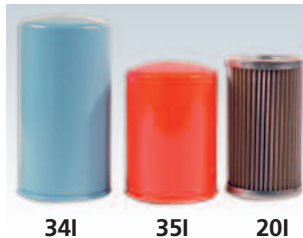

All types Komori oil filters in stock

Komori Oil Filter (Blue)
Part# F3Z0-2600-34I

Komori Oil Filter (Orange)
Part# F3Z0-2600-35I

Komori Oil Filter 3Z0-2600-19I
Part# F3Z0-2600-19I - (paper)
Part# F3Z0-2600-20I - (metal)

Ink Eliminator



The Eliminator is a durable nylon mesh bag filled with ink absorbant material which effectively prevents contamination of the dampening system. Simply place in the circulation tank and it will float on the surface of the fountain solution removing all emulsified ink.

Size: 200 x 115 x 25mm (8" x 4.5" x 1")
Packing: 4 pieces per bag
(8 pieces per box)

RECIRCULATION FILTERS

Code: FILTER01 For Roysse systems. Also widely used on all types of Heidelberg, Komori and Roland presses where a hose can easily be fitted to return-flow.



Code: FILTER02 For Master Flow systems. Also used on some Roysse systems.

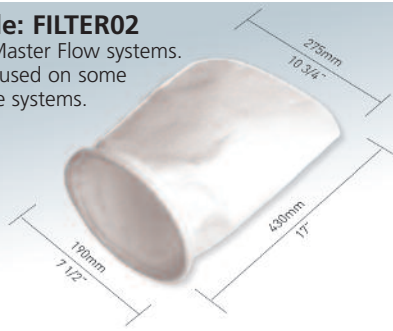

Code: FILTER03 For Technotrans systems (old style)

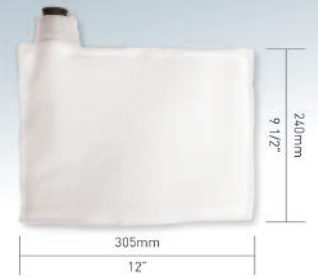

Code: FILTER04 For Technotrans systems (new style)



Code: FILTER05

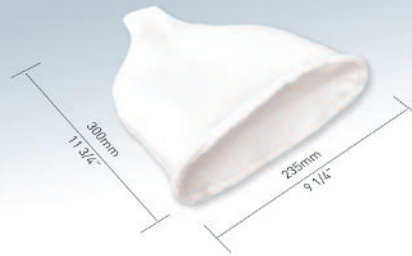

Code: FILTER06 Predominantly used on Technotrans Alpha D circulation systems fitted to Heidelberg, Komori, Roland and various other presses. Can also be used on Baldwin units which have similar neck fitting.



Code: FILTER07



Code: FILTER08



Code: FILTER09

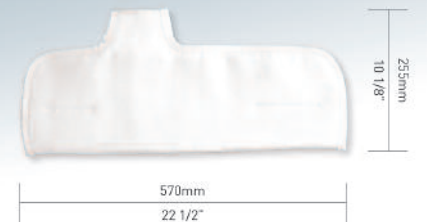

Code: FILTER10



Code: FILTER11



Code: FILTER12

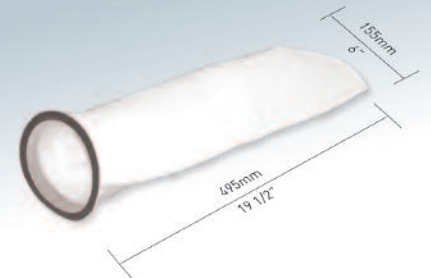

Code: FILTER13



Code: FILTER14



Code: FILTER15

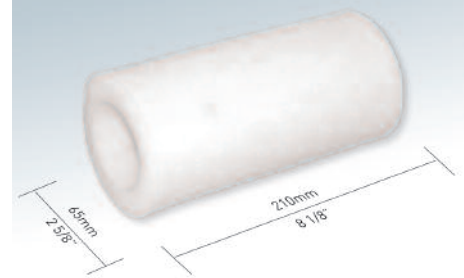

RECIRCULATION FILTERS

Code: FILTER16 Outer material: Nylon



Code: FILTER17

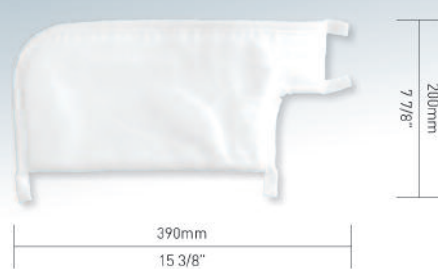

Code: FILTER18

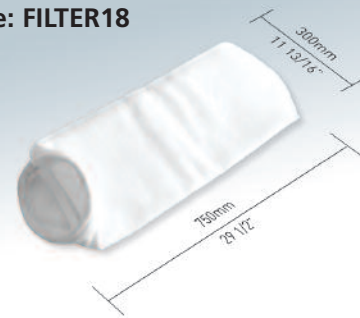

Code: FILTER19



Code: FILTER20

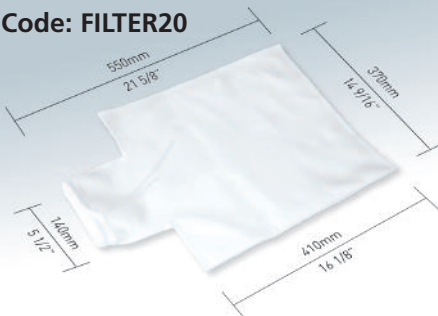

Code: FILTER21



Code: FILTER22

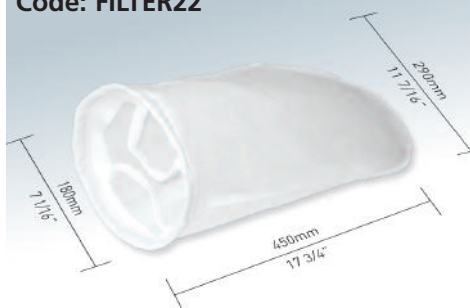

Code: FILTER23



Code: FILTER24



HAND CLEANERS

Citrus Hand Cleaner with Pumice • Scrubs-In-A-Bucket
Citrus Hand Cleaner • Hand Cleaner Dispenser

Citrus Hand Cleaner with Pumice



Gent-I-kleen's Citrus Hand Cleaner is a petroleum solvent-free, natural formulation developed to address environmental & safety concerns. Made with pumice, this blend of premium natural citrus oils safely and effectively dissolves the very toughest soils. This super fast cleaner is pH balanced and has 5 conditioners (aloe vera,

glycerine, vitamin E, jojoba and wheat germ extract) to help keep your hands soft and smooth.

• Contains antiseptic agent • USDA Authorized, E-4 • Biodegradable
Part# HC25218 (1 gallon bottle)

Citrus Hand Cleaner



Waterless citrus scented hand cleaner with extra fine pumice. Takes off many difficult to remove substances. Gentle to hands.

Part# HC374 4.5 lb. can

Scrubs-In-A-Bucket



- One-step towel with proven pumice performance does it all.
 - Pre-moistened, heavy duty towel with pumice scrubbing power.
 - Works fast to loosen, dissolve and absorb dirt and grease.
 - Contains germ-fighting Triclosan
 - Conditions and softens hands
- Part# SB1025** (72/bucket)

Hand Cleaner Dispenser



This high-tech dispenser has a rugged plastic construction, with stainless steel working parts. It dispenses product from the inverted top of the can. The classic black finish maintains a clean appearance. For economy, the dispenser is precision engineered to pump just the right amount of hand cleaner needed with one-hand operation. Extensively tested for strength and durability. Made with noncorrosive plastic and stainless steel parts, it has no gears or ratchets to malfunction.

Part# HCD0-7110

Wash-Up Bottles



Stem molded in one piece for leakproof service. Tip dispenses uniform stream. Available in 16 oz. and 32 oz.

Part#	Description
WU32	32 oz. wash-up bottle
WU16	16 oz. wash-up bottle
FT32	32 oz. flip-top bottle
FT16	16 oz. flip-top bottle

Addition and Deletion Pens



DELETION PENS

Deletion pen – fine 10 pcs/box **Part# 2DPENF**
Deletion pen – large 10 pcs/box **Part# 2DPENL**
These pens can be used on all positive and most negative plates.

ADDITION PENS

Addition pen – fine 10 pcs/box **Part# 2ADPENF**
Addition pen – large 10 pcs/box **Part# 2ADPENL**
These pens can be used on all positive plates.

Etching Needles



- Used for scribing lines on film or directly onto the plate.
- Excellent for filling in lines and letters directly on press.
- Hardwood shafts with steel points. Sizes #00, 0, 1, 2, 3, 4, 5, 6.

Scotch Brite Pads



Scotch Brite Pads. Used for cleaning dried ink, and grime off surfaces. Steel wool effectiveness, yet safe for blankets & rollers.

Part# SB96

Green Nitrile Gloves



Premium-quality nitrile gloves that offer excellent protection against cuts and punctures, and chemical resistance against solvents and caustics. Embossed texture improves wet grip. (Sold by the dozen)

Part# GL3600	Medium
Part# GL372L	Large
Part# GL372XL	Extra Large
Part# GL372XXL	XX Large

MAPA Knit-Lined Neoprene Gloves



Neoprene provides superior performance in chemical and wear resistance. Reliable hand protection against a broad range of chemicals and fluids. Roughed grip. (Sold by the dozen)

Part# GNL-34L	Large gloves
Part# GLNL34XL	X-Large gloves

Disposable Rubber Gloves



High quality latex glove. Lightly powdered for smooth, comfortable fit. Available in S, M, L, XL (100 per box).

Part# GL80	Medium
Part# GL90	Large
Part# GL100	Extra Large

Dust Masks



Disposable mask is lightweight and comfortable. Features a metal nosepiece which adjusts to fit each individual user. (50/box)

Part# DM8500

Pre-Shaped Foam Earplugs



Max Pre-shaped foam earplugs feature a smooth, soil-resistant outer skin that helps prevent foreign material from penetrating the surface while being rolled. Packed in individual poly bags. Available with cords and without.

Part# EPMAX1	Max uncoated	200 pr/box
Part# EPMAX3	Max coated	100 pr/box

Conductivity Meters



A variety of meters are available to measure conductivity and/or pH levels.

Part# PH512 Conductivity Meter
 Part# PHM6 pH Conductivity Meter
 Part# CM98311 Hand Held Conductivity Meter with Temp.

Lithographic Alcohol Testers



Alcohol Testers give you a reading in seconds using less than a half-ounce of solution. The key to this simplicity is the presence of etch and gum arabic and are effective in the temperature range of 40°F to 50°F.

Part# LA028 Alcohol Tester Wide Range
 Part# ATLR Alcohol Tester Low Range

Static Tinsel

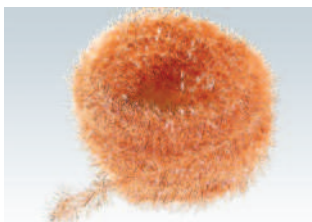

Quality all copper Tinsel removes static from machine processes (24 yard roll)

Part# ST7

Razor Blades and Exacto Knives



#12 Industrial Razor Blades
 Part# RB111-12

Exacto knives
 Part# EK119-01

Exacto blades (100/box)
 Part# EK119-11

Thermometer

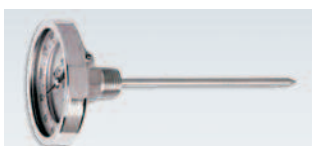

Thermometer 3" head x 6" stem
 Bi-Metal
 Part# THERM

Digital Micrometer



- .0001" Graduations on Vernier Scale; read digital counter to .001"
- Ratchet stop and lock nut
- Satin chrome finish on sleeve and thimble
- Carbide faces on anvil & spindle
- Fitted case w/adjusting wrench
- Sizes 1-2" and larger furnished with standards
- All sizes have baked enamel finish; 0-1" also has heat shields

Part# DM76350016

Measure Viscosity of Coatings



#3 ZAHN Cup - Series 90 - measures viscosity of coating.

Part# AN8965

Absorbent Drum Top Covers

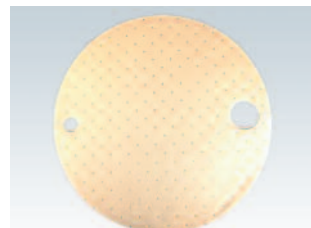

- Keeps drum & floor around the drums clean
- Precut to 55 gallon drums with bungs
- 25/box

Part# AS320

Absorbent Mats



A heavyweight dimpled material notable for its low linting, thickness and strength. Highly effective for clean up and removal of oil and water based liquids. (100/box)

Part# AS322

Absorbent Socks



Around your equipment, under your machinery, these versatile WipeMates® absorbent socks can be used to absorb and contain leaks or spills of all kinds. Available in 2 types, general purpose (3" x 42") and oil only (3" x 48"). These absorbent socks are handy for containing spills or leaks of water, oils or solvents, they can absorb up to 12 times their weight, up to 10 pounds in liquid, depending on the type of fluid. Part# AS326

Cheesecloths



Milled specifically for graphic arts applications and hospital grade clean, WipeMates® cheesecloth is ideal for applying gums and buffing plates to a streak free finish. Available in rolls of 120 - 30" x 36" sheets.

Part# CC440

Paper Drills & Drill Blocks

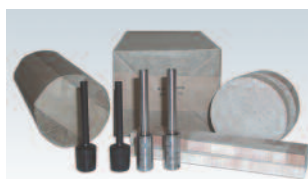

Made to extremely high standards of quality, the mirror finish makes it easy for chips to clear, avoids choking and breakage, cutting edge stays sharp longer, all features add to longer drill use. Available in regular and Teflon.

Challenge	2" long, 1/8 to 1/2" dia.
Challenge 2	1/2" long, 1/8 to 1/2" dia.
Nygren Dahly	3 1/2" long, 1/8" to 1/2" dia.
Lawson	3 1/2" long, 1/8" to 1/2" dia.
Lawson	4" long, 1/8" to 1/2" dia.
Seybold	1/8" to 1/2" dia.

Paper Pile Corners



- Precision cut to exact height and uniformly bent
- Conveniently punched holes for easy handling
- Rounded corners and edges to protect hands and fingers
- Space saving - easily stacked and stored in a cabinet

Part #	Size (HxW)
PPCRNR5X5	5" x 5"
PPCRNR6X5	6" x 5"
PPCRNR7X5	7" x 5"
PPCRNR8X5	8" x 5"
PPCRNR9X5	9" x 5"



Plastic Pile Separators



Manufactured with thin, smooth and extra strong lead edges these paper wedges are easily inserted in paper stacks without damaging stock. Made of high strength, durable polypropylene which will not absorb oil, ink or dirt. Equipped with handy finger sized holes for easy removal from the paper pile. Our paper wedges ensure accurate leveling of paper stacks and with their long taper permit fine adjustments.

Part# WEGS	Small wedge 200x30x30mm (7 7/8"x1 5/16"x1 1/4")
Part# WEGM	Medium wedge 200x60x30mm (7 7/8"x1 3/8"x1 1/4")
Part# WEGL	Large wedge 200x75x25mm (7 7/8"x3 3/8"x1")
Part# WEGB	Baby Wedges (100 x 30 x 33mm) 4 pcs/box

Loupes

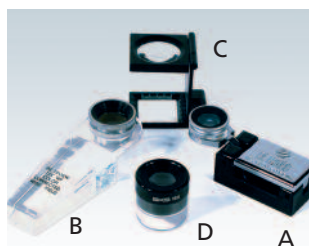

Part#	Description
A) FL10	Folding Loupe 10X
A) FL12X	Folding Loupe 12X
A) FL20X	Folding Loupe 20X
B) LL10X	Plastic based Loupe 10X
B) LL12X	Plastic based Loupe 12X
B) LL20X	Plastic based Loupe 20X
C) SL6X	Stand Up Loupe 6X
D) J-10X	Magnifier 10X

Torque Wrench



Tension Kit for Blanket - For a long time the problem of accurate tension of the printing blanket on the blanket cylinder has been a major concern. A Blanket which is properly mounted guarantees:

- Extra durability and extended blanket life.
 - Superior printing quality and results
 - Improved compressibility and smash resistance.
- Tension can be adjusted to work on any press. The one piece solvent resistant polypropylene construction provides for durability and light weight, with no danger of damaging rubber, plastic or teflon parts on press. **Part# W2722**

Paper Puck

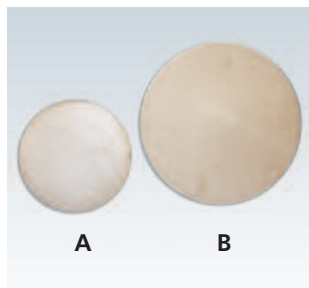

The PAPER PUCK allows the paper handler to turn paper rolls easily and safely.

- Allows roll to be turned in any direction with ease even in a confined area such as a roll stand.
- Minimizes damage to outer wrap of paper.
- Reduces risk of injury
- Available 8" and 12" diameter.
- Durable construction

Part# PA8	A - 8" Paper Puck
Part# PA12	B - 12" Paper Puck

Scotch Hones



A proven satisfactory replacement of the original Tam-O-Shanta Scotch Hones made in Scotland that are no longer available. The domestic hones look and work the same as the Scotch Hones.

Part# OPS14

Spigot



Spigot 3/4" for 5 gallon cubes

Part# AN103503

Bearing Puller



Grip-O-Matic ; 2 Jaw Puller.

Part# BP1022 DSC02541e

Box Cutter



Heavy Duty Cutter - This knife is for demanding applications with ratchet wheel blade lock and steel shank. 3" head x 6" stem Bi-Metal

Part# C300

Drum Wrench



Wrench for 55 gallon drums

Part# AN0168

Deletion Gel



Easy to work with. For positive and negative plates.

Part# IR74

Super Image Remover



Quick and easy to use. Strong fluid deletes large areas on metal litho plates. 3.4oz bottles.

Part# IR34



Blanket Revive

To repair blanket damage, apply Blanket Revive to the damaged area of blanket using the applicator brush. Leave for a few seconds and wipe clean. (8 oz. bottle)

Part# REVIVE

Blanket Saver

Blanket Saver is applied to the back of the blanket in the damaged area. (8 oz. bottles)

Part# BS8

Blanket Scrubbers



The Blanket Scrubber is the first practical improvement in cleaning, loosening, and lifting ink, gum, casein, clay, enamel, varnish, paper lint, and spray powder from the blanket as well as rollers and press frames, effortlessly and thoroughly. The Blanket Scrubber is a nylon pocket containing a cellulose

sponge that holds a reservoir of solvent. The Blanket Scrubber easily outlasts the equivalent of 300 or more shop towels, reducing laundering bills better than 50%. Unlike the limp fibers of shop wipes that clog easily, the open mesh and scrubbing action of the Blanket Scrubber completely cleans and renovates the blanket surface with every wash-up.

Part# BS350

Natural and Cellulose Sponges



Part# S6F Cellulose Sponge (6F) 6" x 3" x 1"

Part# S8F Cellulose Sponge (8F) 6" x 4 1/4" x 1 11/16"

Part# S1DF Cellulose Sponge (1DF) 4 1/4" x 4" x 2 1/4"

Part# S4S Natural Sea Sponge

Plastic Ink Knives

The one piece solvent resistant polypropylene construction provides for durability and light weight, with no danger of damaging rubber, plastic or teflon parts on press.



Part #	Blade Size	Overall Size
A37	3" x 7 1/2"	13 1/2"
B54	5 1/2" x 4 1/2"	11"
C44	4" x 4"	11"
2KNIFEJ	11 3/4" x 3 1/8"	White
2KNIFE	10 3/4" x 2 3/4"	Cyan, magenta, yellow and black set for 4 color presses



Plastic Web Knife



A versatile tool created by combining the capabilities of the web knife with the world of hi-tech plastics. The plastic web knife can be safely and easily used to remove kraft outer wraps, damaged paper and even wrap-ups on press. Because it is both heat and solvent resistant, the web knife is a long lasting tool offering savings from the first time you use it.

Part# RCUT

Metal Ink Knives

Lamson ink knives are industrial and tradesman quality, produced from extra heavy gauge hi-carbon steel. Blades are full tang and brass compression riveted to walnut handles. They will give long service and satisfaction. All sizes available for immediate delivery.



	Part #	Overall Size
A	IK900-8	2 1/4" x 8" x 13 1/2"
B	IK900-6	1 5/8" x 6" x 11"
C	IK9103E-3	3" x 4 1/2" x 8 1/2"
D	IK900E-2	2" x 3 5/8" x 7 1/2"
E	IK900E-112	1 1/2" x 3 5/8" x 7 1/2"
F	IK6S05-4	3/4" x 4" x 7 3/4"

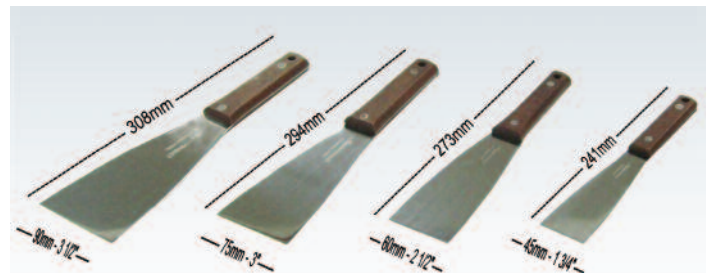

KNIFEMT90 KNIFEMT75 KNIFEMT60 KNIFEMT45

Web Knife



The Web Knife offers the most efficient and cost effective method of opening paper rolls. By eliminating the erratic cutting of razor knives, the Web Knife minimizes paper waste. On a yearly basis, thousands of

dollars are lost by as little as 1/16 inch per roll routinely wasted. Constructed of a durable, lightweight, metal alloy, the Web Knife will provide years of dependable service.

Part# WK

Webril®



Webril® nonwoven material is a unique, high quality fabric manufactured by Fiberweb® for the Graphic Arts Industry. Our exclusive felting process produces 100% pure cotton products. No binders or chemicals are present. WEBRIL products will not react or contaminate developing solutions or chemicals commonly used in the printing industry. The interlocked fibers won't come apart, even when soaked in water or solvents. WEBRIL products will not scratch the most delicate coatings or surfaces. It is this process which insures the soft, pure and highly absorbent qualities for which WEBRIL wipes and pads have been known and trusted for many years.

KleanWipes®



Economical KleanWipes Wipers are designed for all applications where dust control and static neutralization is critical. KleanWipes are soft, yet strong and absorbent. KleanWipes won't scratch the most delicate coatings or surfaces. And because they're disposable, you reach for a clean wiper everytime. Ideal for use for all types of general cleanup.

KleanWipes are packaged in a convenient dispensing box with a lint reducing anti-stat polyshield.

Hyton® Dampener Covers



Hyton fibers are highly ink-resistant, so the covers will run cleaner, providing longer life. There is a Hyton dampener cover for virtually every offset press.

Nubtex® Shop Cloths



Versatile Nubtex Shop Cloths provide a totally new approach to pressroom cleaning. Made from an advanced cloth material, Nubtex Shop Cloths are soft, absorbent, and extremely durable. Nubtex Shop Cloths combine the characteristics of cloth towels with the ease and convenience of disposable wipes. Nubtex Shop Cloths are ideal for cleaning blankets, rollers and ink trays, as well as for all types of general cleanup. And since Nubtex provides the assurance of a fresh towel each time, there is no unwanted metal debris to worry about.

Web-Lock® Splicing Tapes



All Web-Lock splicing tapes are designed to deliver high performance and are tested to ensure the proper degree of tack, adhesion and shear strength.

Photex®

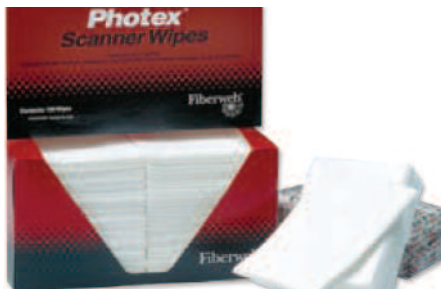

Photex scanner and screen wipes are ideal for use wherever dust control and static neutralization is critical. Specifically designed to reduce or eliminate static build-up, each wipe is treated with a highly effective, dry antistatic agent that guarantees no oily residue on surface or hands.



Photex Wipes are soft, absorbent and lint free. Photex Wipes contain no chemical or polymer binders, so they won't scratch sensitive surfaces. (Unlike paper wipes, Photex won't scratch even after repeated use.)

Snowtex® Cloth Wipes



Snowtex wipes offer unique quick dry characteristics that are extremely important with today's low VOC solvents. Snowtex cloth wipes are extremely soft and absorbent.

FlexTex® Plate Wipes



FlexTex wipes are heavyweight, extremely low lint wiping pads that can absorb up to 10 times their own weight in ink or cleaning fluids. They are ideal for cleaning flexo plates.

Red 1® SHRINK Dampening Material and Red Runner™



RED•1 SHRINK Dampening Material incorporates the latest developments in fiber technology. Its unique knit construction guarantees a controlled and uniform circumferential shrink that firmly locks the cover onto the roller without pinching down the roller ends. The shrink fit eliminates any twisting or creeping even under high speed web press conditions. No special rollers are required and the problems and expense associated with critical roller tolerances are eliminated.



Red Runners advanced new fiber technology sets it apart from other dampening sleeves. Red Runner Dampening Sleeves provides the ultimate in slip-on, shrink fit design. Its unique fiber system delivers unprecedented control of ink/water balance. Red Runner Dampening Sleeves are long lasting, clean up easily and are lint-free. Unlike rigid tubes, Red Runner sleeves can't break, crack, split or shred. The problems of low spots, mourning bands and critical roller tolerances are eliminated. And its consistent ultra-fine surface achieves a new level of pattern-free printing performance.

Pre-Saturated and Dry Blanket Cleaning Cloth

A patented cleaning textile that can improve your bottom line.

- Improves productivity as much as 50%!
- Reduces paper waste!
- Reduces press down time!

It's all about the textile. Made with a patented, lint free/wood pulp free textile, utilizing continuous ultra fine filaments...7 times smaller than silk. The ultra fine fibers provide an aggressive cleaning action through the increased surface area of the fine fibers. The fibers also provide the ability to consistently and uniformly retain and distribute LoVOC solvent to the blanket during cleaning. Blanket cleaning cloth rolls can be made for virtually any press make or model including: Heidelberg, KBA, Komori, Akiyama and others.

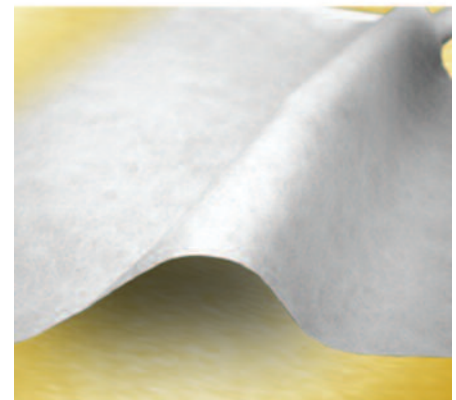
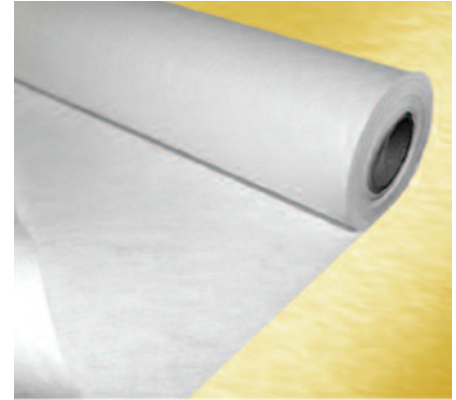

Special lint free high efficiency cleaning textile for use in Offset Printing Perfecting Systems and Automatic Blanket Cleaner Systems. **Our improved Offset Printing Perfecting System Blanket Cleaner is manufactured with a UNIQUE Patented Technical Textile. The textile is shed free, lint free, and displays increased strength, decreased stretch, improved abrasion resistance, and superior cleaning!**

Everclean™ Blanket Cleaner Scanning Electron Microscope Photographs		
10 X	100 X	500 X
A Continuous Filament Textile which contains Fibers with an INFINITE Length and thus Yields LOW Fiber Shedding!	Ultra Fine Filaments. Yield Very High Surface Area which leads to Excellent Cleaning!	100% POLYMER FIBERS and thus absolutely NO "Lint" (Cellulose Fiber) Contribution to Print Blanket!

Blue Blanket Cleaner Scanning Electron Microscope Photographs		
10 X	100 X	500 X
A Staple Fiber Textile which contains very short fibers (Fractions of an inch length.)	Much Coarser Fibers which gives the Textile Surface Much Lower Surface Area.	Greater than 50% wood pulp content.

Part#	Description
SU1	KLUGE, paper suckers. Red or gum rubber.
SU1P	PLASTIC SUCKER. Longer life.
SU1a	KLUGE Narrow Margin Sucker, very handy in tight places.
SU2	KLUGE, card suckers. Red or gum rubber.
SU3	KLUGE, carton suckers. Red or gum rubber.
SU4	UNIVERSAL TIPS, light duty. C&P, Giant, Web, Chief and Kluge.
SU5	UNIVERSAL TIPS, heavy duty. C&P, Giant, Web, Chief.
SU6a	MACEY COLLATOR HARRIS pickup sucker for cardboard.
SU7	HARRIS old style. Giant Web, Chief, Harris, for cardboard. Gum rubber, thin, regular or heavy, or black poly.
SU8	HARRIS old style. Giant, Web, Chief, Harris, for paper.
SU9	MILLER Simplex, Major, Southworth envelope press suction feed. Fits 1/4" tube. For paper.
SU10	MILLER Simplex, Major, for cardboard. Gum rubber or black.
SU11	HARRIS 90 ELB fits most presses. Mann, Macey Collator & Stitcher. 6E7—paper. 6E8—cardboard. HTB—Miehle feeders.
SU12	HARRIS 1361 LTN fits most presses, for paper. Gum rubber or silicone.
SU13a	MIEHLE CS3122 FEEDER, Superchief light forwarder, Miller, Diddle Glaser Collator, for paper.
SU13b	MIEHLE CS3124 FEEDER, Superchief Heavy forwarder, Dexter, Giant, for cardboard. Both fit Ebco presses.
SU14	MIEHLE CS427 FEEDER, Farrington Collator, Giant, Web, Chief, for paper.
SU15	MIEHLE CS1026 FEEDER, Giant, Web, Chief, for cardboard.
SU15a	MACEY COLLATOR, Harris pickup sucker, for paper.
SU16	C&P, RICE, Kluge "D" Delivery, for paper and light cardboard.
SU17	KLUGE for narrow margin work. Use on feeder or delivery.

Part#	Description
SU18	KLUGE, same as SU17. Rubber disc SU19K added for cardboard.
SU19	FLAT RUBBER SUCTION DISCS, Over 50 different sizes available up to 2". Submit sample.
SU20	WASHERS: Miehle Vertical (a) feedboard, (b) gripper bar, (c) gripper head (thin)
SU21	SANDPAPER DISCS, (a) ready glued, (b) without glue. Kluge, C&P, others. Standard 3/4" or extra large 1 1/8"
SU22	HEIDELBERG SUCKER, KLUGE, new style. 7/8" across. Delivery gripper will not tear this.
SU23	RUBBER SUCTION TIP, 5/8" across—fits inserting & gathering machines. Sheridan, McCain, Phillipsburg. Various compounds available. Submit sample.
SU23a	DEXTER RGA 717, raised inside pattern for light stock. Submit sample.
SU26	KLUGE METAL CAP holds standard rubber sucker. For feeder and delivery.
SU27a	BRASS SUCKER for Chief and Webendorfer Offset Presses, for paper.
SU27b	BRASS SUCKER for Chief and Webendorfer Offset Presses, for cardboard. Add a SU4, SU7, SU8, SU14 or SU15 rubber sucker.
SU28	MIEHLE FEEDER CAP shuts off openings on feeder bar.
SU29	(a) MIEHLE VERTICAL Fluffer Wires for paper; (b) MIEHLE VERTICAL Fluffer Wires for cardboard; (c) THUMB SCREW for Fluffer Wires, includes washer.
SU30a	MIEHLE VERTICAL Air Release Valve. Used on feeder arm instead of SU28 cap. Release a little air by turning screw. Excellent for cardboard & tissue.
SU30b	MIEHLE VERTICAL Cylinder Gripper, Complete only. Fits all Verticals.
SU32	JOB PRESS Gripper Fingers. Fits Kluges, C&P, etc. Short, long, extra long. Standard & narrow widths.
SU33a	KLUGE SHEET TONGUES. Sizes 1 to 6.
SU33b	SHEET TONGUE SCREW. Fits all Kluges. Includes washer.
SU34	MIEHLE VERTICAL TRANSFER TABLE LEVER KEY. Keeps feed board in place. Fits all models.
SU35	MIEHLE VERTICAL BACK-STOPPS. Fits all plain boards.

Part#	Description
SU36	KLUGE REGISTER ROD CAM, left or right.
SU38a	ENDLESS BELTS, Vertical & Kluge. Leather for drive & motor. CONVEYOR BELTS for: MULTILITH—1250 and 1250-W, Fabric. CHIEF 15-17, Fabric
SU39	TELESCOPING SUCKER for ATF Chiefs except Super Chief & Chief 15. Used with flat disk SU19K.
SU40	FEED SUCKER BLOCK for Chief 20, 22, 29 presses. Holds Part E.
SU41	VERTICAL PIN WRENCHES, (a) Straight type, small & large; (b) "S" type, small. (d) Komori pin wrench
SU43	KLUGE REGISTER ROD HOLDER.
SU44	KLUGE WRENCH SET, Includes all popular nuts and bolts; (a) Complete 7 piece set; (b) Wrench; (c) Gripper nut; (d) Side guide nut; (e) Delivery pickup bolt; (f) Delivery track bolt.
SU45	KLUGE MISCELLANEOUS PARTS. Fits all models; (a) Side guide tongue (b) Magazine separator spring (c) Center comber spring (d) Side guide eyebolt holds side guide to platen.
SU46	BOOK TRIMMING GUIDES. Challenge style. Bolt portion fits on back finger gauge of cutter. Keeps any size booklets flat for trimming.
SU47	BOOK TRIMMING GUIDES. Economy style. Fits on back gauge of cutter.
SU48	KLUGE, (a) Delivery pickup bolt (b) Delivery pickup clamp top (c) Delivery pickup clamp base. Specify left or right; (d) Delivery pickup suction tube.
SU51	KLUGE; (a) Kluge Side Guide, complete. Left or right; (b) Kluge Side Guide Black (c) Bottom Feed Gauge (d) Feed Gauge Tongues only (e) Kluge Side Guide, complete with offset stem. Left or right.
SU52	KLUGE; (a) Kluge bottom Gauge Band. Specify length—19-1/2", 23-1/4" or 25-1/2"; (b) Kluge Bottom Gauge Band Clamp. Quick release; (c) Kluge Bottom Gauge Band. Clamp with screw to hold band. Specify left or right.
SU53	BLOWER FLEXIBLE STEEL TUBING. Fits all Kluges. 5' length.

Part#	Description	Part#	Description	Part#	Description
 SU54a	KLUGE. Cardboard, left (KG-571)	 SU73	A. B. DICK metal telescoping sucker. Comes with #19K discs. For difficult and wavy stock.	 SU93	MULLER 020.1913. Collating and gathering machines.
 SU54b	KLUGE. Cardboard, right (KG-571A)	 SU73p	A. B. DICK Plastic telescoping sucker with shut-off valve. Comes with a #66 sucker.	 SU94	PHILLIPSBURG inserters, bellows type. Black.
 SU54c	KLUGE. Paper, left (KG577)	 SU74	A & B SET—MULTILITH or HAMADA telescoping suckers. Uses #19K discs. For difficult and wavy stock.	 SU95	MCCAIN, bellows type.
 SU54d	KLUGE. Paper, right (KG577A)	 SU74c	NEW STYLE M ULTILITH telescoping sucker. 1250–1250W and 1850. Comes with #19K discs.	 SU96	HARRIS/AURELIA, bellows type. 1-1/4" across, 1" high.
 SU54e	KLUGE. dummy (KG580)	 SU75	CHIEF 15 & 17 telescoping sucker. Uses #19K or 19 A.B. DICK discs. For difficult and wavy stock.	 SU97	RYOBI, 5640-35-531. Clear or white.
 SU55	MF MIEHLE FEEDERS, MF 3968 and ATF Superchief pickup suckers.	 SU76	MULLER collating and gathering machines. Red or black.	 SU98	MULLER, 020.1901. Orange rubber cap.
 SU56	MF MIEHLE FEEDERS, MF 3336 and packaging machines. Fits 1/2" tube. For light stock. Gum rubber or Neo.	 SU77	MULLER collating & gathering machines. Green or black.	 SU99	HEIDELBERG 42.016.073. For GTO. Black bellows.
 SU57	HARRIS 1108, fits 5/8" tube, for heavy stock.	 SU78	HAMADASTAR printing press.	 SU100	NORFIN COLLATOR.
 SU58	MIEHLE STREAM FEEDERS, CS11398, packaging machines. Occasionally replaces 3122, 3123, 3124. Fits 1/2" tube—1-3/8" across. Gum rubber or Poly.	 SU79	ASTRO & SANDMAR envelope & sheet feeders. Specify medium or heavy.	 SU101	UHLMANN PACKAGING MACHINES.
 SU59	HARRIS 956-ELB. Fits 5/16" tube. 1-3/8" across. For light stock.	 SU80	ATF—Commander 29 Speiss feeders, Heidelberg. For light stock.	 SU102	HORIZON COLLATOR, 3013. Small dark grey sucker.
 SU60	MF MIEHLE FEEDERS, MF 3558 packaging machines, Superchief tissue suckers. Fits 1/2" tube—1" across. For light stock. Gum rubber or Neo.	 SU81	KLOCKNER 18092-1 packaging machines. 1-1/8" across, 1/2" high. Black, red, blue or tan.	 SU103	HORIZON COLLATOR, 3015. Large blue sucker.
 SU61	HARRIS 391-ELB. Fits 5/16" tube—1-3/8" across. For heavy stock.	 SU82	RYOBI. Ryobi-Itok. Regular and heavy.	 SU104	DUPLO COLLATOR, bellows-type sucker.
 SU62	CS MIEHLE FEEDERS, CS-357. 1-1/4" across.	 SU83	HEIDELBERG GTO offset presses. Gum rubber or Red poly.	 SU104a	HORIZON COLLATOR, bellows cup, clear silicone.
 SU63	SHERIDAN and other collators with 1/8" tube.	 SU86	KLOCKNER 18092 packaging machines. 1-1/2" across, 3/4" high. Black, red, blue or tan.	 SU105	HAMADA bellows cup, 6901-05057
 SU64	MIEHLE FEEDERS, K-1196.	 SU88	HAMADA CK 02-77 printing presses.	 SU106	BOURG MODULEN COLLATOR, vinyl.
 SU65	SHEET SEPARATORS (Cat Whiskers). For small offset presses. Specify press: Multilith or Hamada, Davidson, Chief, Ryobi-Itok, Komori or Fuji.	 SU89	HARRIS 398-0026. 7/8" across bottom.	 SU107	A. B. DICK CENTURY 3000. Bellows type sucker.
 SU66	A. B. DICK, BIG FOOT, molded sucker. For all presses with 1/4" bottom tube. Regular & heavy.	 SU90	TOKO DYY-9-R1, MULTI 1218-CJ-11, IMPERIAL CH-11. Bourg Modulen Collator.	 SU108	MITSUBISHI. Pick-up Sucker. Black.
 SU67	HARRIS polyurethane, 3361-LTY. Occasionally replaces 59 & 61. Fits 5/16" tube 1-3/4" across. For heavy stock.	 SU91	HAMADA H05-49-01-3. Black plastic tube. Hard or soft.	 SU109	PHILLIPSBURG. Bellows cup, Blue or Tan
 SU68	HEIDELBERG Cylinders. Cupshape prevents snap-back. 1-1/8" across.	 SU92	HEIDELBERG 22.016.008. For T-Press TOL-TOM.	 SU110	HTB FEEDER
 SU69	GRIPPER BOLTS for C&P or Kluge. Sold in pairs.	 SU92Q	HEIDELBERG QUICKMASTER.	 SU111	MULLER MARTINI 020.1924 Black cup with cleats
 SU70	RYOBI/ITEK telescoping sucker. Comes with #19R discs.			 SU112	HARRIS (A520-00-1245)

Part#	Description
SU116	HEIDELBERG (2144-243-01-00) Stitchmaster sucker
SU117A	DEPANNER CUP Flat Top, 42mm OD, Metal Detectable
SU117B	DEPANNER CUP Extra Soft, Flat Top, 42mm OD, Metal detectable
SU118A	DEPANNER CUP Taper Top, 40mm OD, Metal detectable
SU118B	DEPANNER CUP Extra Soft, Taper Top, 40mm OD, Metal detectable
SU118C	DEPANNER CUP, Clear silicone, taper top, 40mm OD, not metal detectable.
SU119B	DEPANNER CUP Extra Soft Taper Top, 35mm OD, Metal detectable
SU120B	DEPANNER CUP, Extra soft, taper top, extra thin lip, 42mm OD, metal detectable.
SU120C	DEPANNER CUP, Clear silicone, taper top, extra thin lip. 42mm OD. Not metal detectable.
SU122F	FITTING For all Depanner Cups, Metal detectable
SU122FH	FITTING For all Depanner Cups, Hard, Metal detectable
SU122FL	Fitting, for all depanner cups. Extra tall, metal detectable.
SU122T	TOOL To install Depanner Cup Fittings
SU123	1" CUP, soft tan, with flange.
SU124H	CHIEF 24 Heavy. For Heavy stock.
SU124L	CHIEF 24 Light. For Light stock.
SU125	CUMMINGTON collar, Miehle vertical for cardboard.
SURTF	1999 MIEHLE TF & other feeders. Cardboard or sheet metal. 1-7/16" high, 1-9/16" across. Fits 3/4" OD tube or 1/2" pipe.
SURCS	3121 MIELHE CS & other feeders. For heavy stock or sheet metal. 1-7/8" high, 1-9/16" across. Fits 3/4" OD tube or 1/2" pipe.
SURCS	3123 MIELHE CS & other feeders. For cardboard 1" high. 1-1/4" across. Fits 1/2" OD tube.
SURTF	1648 MIEHLE TF & other feeders. For heavy cardboard or sheet metal. 2-1/8" high, 2-1/2" across. Fits 3/4" OD tube or 1/2" pipe. Gum rubber or Neo.

Part#	Description
SU301	PAPER STOP DEFLECTOR. Clear rigid plastic. Equivalent to Chief M-1-184.
SU302	302 WRENCH, open end. Equivalent to Chief special wrench. W2155x22.

Part#	Description
SU304	DRILL ADAPTER, drill paper with standard wood or metal drill using this Drill Adaptor and Style D Hallo Drills.
KPHS	Plate Hanger Sucker Komori - 10 pcs / pack



Heidelberg Flat Rubber Suckers

PART#	MATERIAL	COLOR	OUTSIDE	INSIDE	THICKNESS	PACKING
2RS38131R	SILICON	Red	38mm 1 1/2"	13mm 1/2"	1mm 3/64"	25 pcs/pack
2RS38138R	SILICON	Red	38mm 1 1/2"	13mm 1/2"	0.8mm 1/32"	25 pcs/pack
2RS38135R	SILICON	Red	38mm 1 1/2"	13mm 1/2"	0.5mm 1/64"	25 pcs/pack
2RS32131R	SILICON	Red	32mm 1 1/4"	13mm 1/2"	1mm 3/64"	25 pcs/pack
2RS32138R	SILICON	Red	32mm 1 1/4"	13mm 1/2"	0.8mm 1/32"	25 pcs/pack
66.028.406/C						
2RS32135R	SILICON	Red	32mm 1 1/4"	13mm 1/2"	0.5mm 1/64"	25 pcs/pack
2RS38131C	"PER" Synthetic	Clear	38mm 1 1/2"	13mm 1/2"	1mm 3/64"	25 pcs/pack
66.028.404/B						
2RS32135C	"PER"	Synthetic Clear	32mm 1 1/4"	13mm 1/2"	0.5mm 1/64"	25 pcs/pack
2RS30138C	"PER"	Synthetic Clear	30mm 1 3/16"	13mm 1/2"	0.8mm 1/32"	25 pcs/pack
2RS24108Y	"PER"	Synthetic Yellow	24mm 15/16"	10mm 3/8"	0.8mm 1/32"	25 pcs/pack
89.028.401/01						
2RS38131G	Natural Rubber	Grey	38mm 1 1/2"	13mm 1/2"	1mm 3/64"	25 pcs/pack
66.028.402						
2RS30138G	Natural Rubber	Grey	30mm 1 3/16"	13mm 1/2"	0.8mm 1/32"	25 pcs/pack
66.028.401						

Roland Flat Rubber Suckers

PART#	MATERIAL	COLOR	OUTSIDE	INSIDE	THICKNESS	PACKING
2RS38151B	Natural Rubber	Blue	38mm 1 1/2"	15mm 19/32"	1mm 3/64"	25 pcs/pack
S992702195						
2RS38157B	Natural Rubber	Blue	38mm 1 1/2"	15mm 19/32"	0.7mm 1/32"	25 pcs/pack
090R600440						
2RS35151B	Natural Rubber	Blue	35mm 1 3/8"	15mm 19/32"	1mm 3/64"	25 pcs/pack
090R600340						
2RS35157B	Natural Rubber	Blue	35mm 1 3/8"	15mm 19/32"	0.7mm 1/32"	25 pcs/pack
2RS32151B	Natural Rubber	Blue	32mm 1 1/4"	15mm 19/32"	1mm 3/64"	5 pcs/pack
090R600240						
2RS32157B	Natural Rubber	Blue	32mm 1 1/4"	15mm 19/32"	0.7mm 1/32"	25 pcs/pack

Man Roland Accordion Sucker For Roland 700 & 300

PART#	OUTSIDE	INSIDE	HEIGHT	PACKING
2RS700/300	30.5mm	15.5mm	15.5mm	12pcs/pack
021F013230	1 13/64"	39/64"	39/64"	

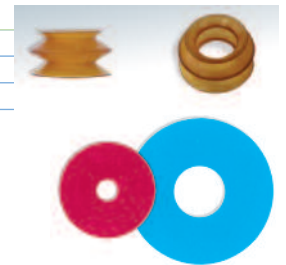

Various Presses Flat Rubber Suckers

PART#	MATERIAL	COLOR	OUTSIDE	INSIDE	THICKNESS	PACKING
2RS38131B	Natural Rubber	Blue	38mm 1 1/2"	13mm 1/2"	1mm 3/64"	25 pcs/pack
2RS38138G	Natural Rubber	Grey	38mm 1 1/2"	13mm 1/2"	0.8mm 1/32"	25 pcs/pack
2RS38135O	Natural Rubber	Orange	38mm 1 1/2"	13mm 1/2"	0.5mm 1/64"	25 pcs/pack
2RS32138G	Natural Rubber	Grey	32mm 1 1/4"	13mm 1/2"	0.8mm 1/32"	25 pcs/pack
2RS30138G	Natural Rubber	Grey	30mm 1 3/16"	13mm 1/2"	0.8mm 1/32"	25 pcs/pack
2RS2188	Natural Rubber	Natural	21mm 53/64"	7.5mm 5/16"	0.8mm 1/32"	25 pcs/pack
2RS2185	Natural Rubber	Natural	21mm 53/64"	7.5mm 5/16"	0.5mm 1/64"	25 pcs/pack
2RS26062R	Natural Rubber	Red	26mm 1 1/32"	6mm 15/64"	2mm 5/64"	25 pcs/pack
2RS22032W	Natural Rubber	White	22mm 7/8"	3mm 1/8"	2mm 5/64"	25 pcs/pack

SHEET SEPARATORS

Heidelberg



Model: Speedmaster/S-Offset
 Thickness: 0.20mm/0.008"
 Description: Sheet separator cpl.
 Fork with bent frame
 Packing: 1 piece
Part# SHEETB1 66.028.810F/01



Model: Speedmaster/S-Offset
 Thickness: 0.20mm/0.008"
 Description: Sheet separator cpl.
 Blade w/bent frame
 Packing: 1 piece
Part# SHEETB2 66.028.110F



Model: Speedmaster/S-Offset
 Thickness: 0.20mm/0.008"
 Description: Sheet separator cpl.
 Fork with flat frame
 Packing: 1 piece
Part# SHEETF1



Model: Speedmaster/S-Offset
 Thickness: 0.20mm/0.008"
 Description: Sheet separator cpl.
 Blade w/flat frame
 Packing: 1 piece
Part# SHEETF2



Model: Speedmaster/S-Offset
 Description: Sheet separator
 Brush
 Packing: 1 piece
Part# SHEETBR1 66.028.109F



Model: Speedmaster 52/74
 Description: Sheet separator
 Packing: 1 set
Part# SHEET74F1 L4.028.164S/
Part# SHEET74F2 L4.028.165S/

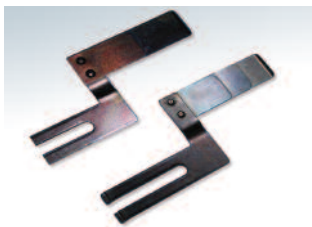

Model: Speedmaster 52/74
 Description: Sheet separator
 Packing: 1 set
Part# SHEET74B1 L4.028.167S/
Part# SHEET74B2 L4.028.168S/



Model: GTO single sheet feeder
 Description: Sheet separator
 Brush
 Packing: 1 piece
Part# SHEETBR2 04.022.069



Model: GTO single sheet feeder
 Description: Sheet separator cpl.
 Brush with clamp
 Packing: 1 piece
Part# SHEETBR2C 04.022.069F/02



Model: Heidelberg GTO46 with
 rubber hood
 Thickness: 0.8mm/0.031"
 Packing: 1 piece
Part# SHEET46R 42.017063F



Model: Heidelberg GTO52
 with rubber hood
 Thickness: 1.0mm/0.039"
 Packing: 1 piece
Part# SHEET52R 43.017.078F



Model: Sheet separator
 for Heidelberg
 SM52
 Packing: 1 piece
Part# SHEETSM52



Model: Sheet separator
 for Heidelberg
 GTO(45'') with
 rubber hood
 Thickness: 0.30mm/0.012"
 Packing: 1 piece
Part# SHEET5245 43.017.079



Model: Rubber hood for Sheet
 separator Heid GTO46
 & GTO52
 Packing: 12 pieces/bag
Part# RHOODGTO



Model: SM105 Sheet
 Separator Fork
 Packing: 1 Piece
Part# SHEET105



Model: SM74 Sheet Separator -
 Blade Drive Side
 Packing: 1 Piece
Part# SHEET74B1

SHEET SEPARATORS



Model: SM74 Sheet Separator - Operator Side

Packing: 1 Piece
Part# SHEET74B2



Model: SM74 Sheet Separator - Fork Drive Side

Packing: 1 Piece
Part# SHEET174FC



Model: SM74 Sheet Separator - Blade Operator Side Blade Drive Side

Packing: 1 Piece
Part# SHEET74B2

Roland

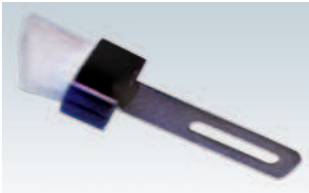

Model: Roland 800
Description: Sheet separator Brush
Packing: 1 piece
Part# SHEET800



Description: Miller KBA Rapida 104 Sheet Separator
Part# MP4952



Description: Sheet Smoother Tabs Teflon
Packing: 12 pcs/pack
Part# TT72190 (66.072.190)



Description: Heid GTO 46 & 52 Hold Down Strap
Part# HE-462281 (42.015.240)

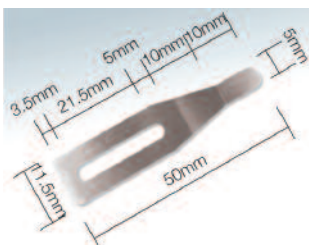

Description: Bent sheet separators for Mitsubishi
Thickness: 0.15mm / 0.006" (mm/inch)
Packing: 12 pcs/bag
Part# SHEETB20

Flat Sheet Separators

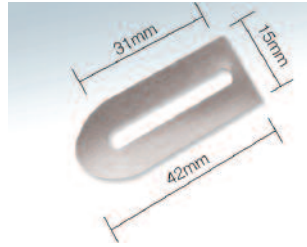

Flat sheet separators for Heidelberg, Roland, Mitsubishi, KBA and Miller
Part# Thickness (mm/inch)
SHEET101 0.10mm / 0.004"
SHEET102 0.20mm / 0.008"
SHEET103 0.30mm / 0.012"
Packing: 25 pcs/bag

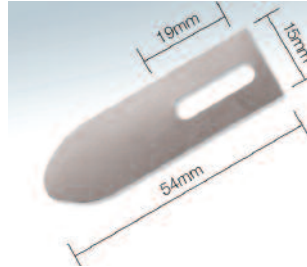

Flat sheet separators for Komori, Fuji-Shinohara and Hashimoto
Part# Thickness (mm/inch)
SHEET201 0.10mm / 0.004"
SHEET202 0.20mm / 0.008"
SHEET203 0.30mm / 0.012"
Packing: 25 pcs/bag

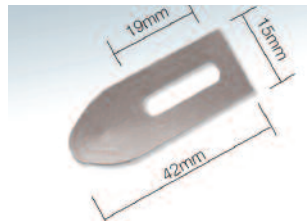

Flat sheet separators for Komori, Fuji-Shinohara and Hashimoto
Part# Thickness (mm/inch)
SHEET301 0.10mm / 0.004"
SHEET302 0.20mm / 0.008"
SHEET303 0.30mm / 0.012"
Packing: 25 pcs/bag

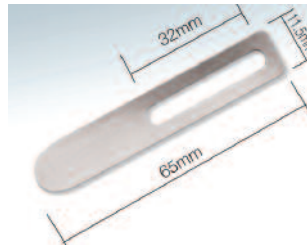

Flat sheet separators for Mitsubishi
Part# Thickness (mm/inch)
SHEET401 0.10mm / 0.004"
SHEET402 0.20mm / 0.008"
SHEET403 0.30mm / 0.012"
Packing: 25 pcs/bag

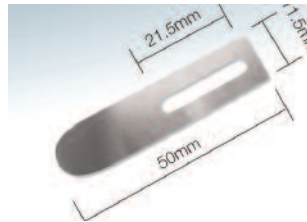

Flat sheet separators for Mitsubishi
Part# Thickness (mm/inch)
SHEET5015 0.15mm / 0.006"
Packing: 25 pcs/bag



Flat sheet separators for Sakurai
Part# Thickness (mm/inch)
SHEET601 0.10mm/0.004"
SHEET602 0.20mm/0.008"
SHEET603 0.30mm/0.012"
Packing: 25 pcs/bag



Flat Sheet separators for Ryobi 750/680/520
Thickness: 0.15mm / 0.006" (mm/inch)
Packing: 25 pcs/bag
Part# SHEET7015

AIR COMPRESSORS AND VACUUM PUMPS

Rietschle Pumps

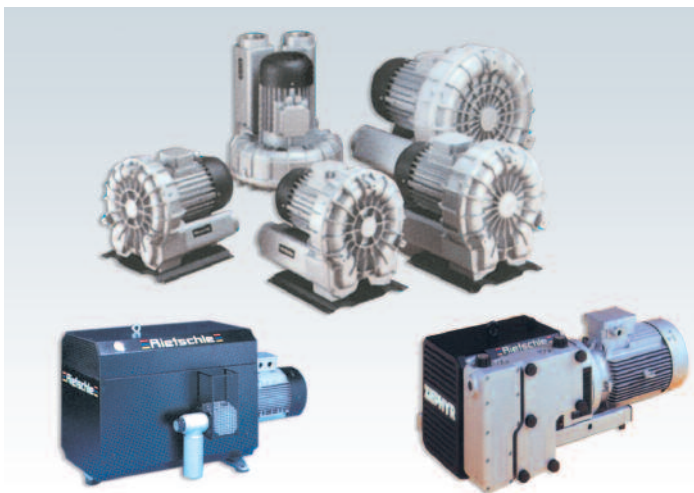

Rietschle's reliable long life products offer the highest performance. New or remanufactured, lubricated or non-lubricated all models available for immediate delivery.

Vacuum Hoses and Tubing



Most sizes in stock and available for immediate delivery.

Connectors and Tube Fittings



Quick-fitting joint for pneumatic tubing. Simply insert the tube, then the lock claws will hold it firmly in place. Push the release ring to release the lock. Available in 4 mm, 6 mm, 8 mm.

Rietschle Carbon Vanes

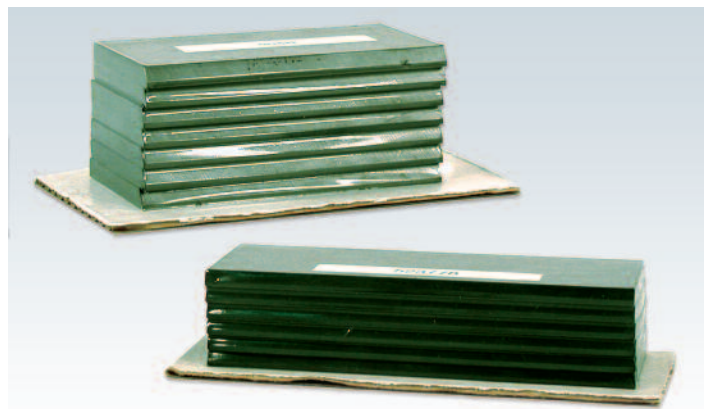

Part#	Pump Model	Quantity in Set	Original Height	Minimum Height
507107	CLFT-41-DV	8	28	22
507108	CLFT-61-all	8	34	25
507109	CLFT-81-DV	8	40	30
507110	CLFT-101-DV	8	40	30
524142	CLFT-141-DV	8	47	34
523777	DTA-60	6	52	38
526886	DTA-80	6	52	38
525977	DTA-100	6	52	38
525421	DTA-140	6	52	38
513455	KLT-10	6	31	20
513702	KLT-15	6	39	24
513431	KLT-25	6	39	24
518943	KLT-40	7	47	35
518943	KTA-40	6	47	27
523777	KTA-60	6	52	38
523851	KTA-80/1,2,3,4	6	52	38
524436	KTA-80/5	8	43	38
525977	KTA-100	6	52	38
525421	KTA-140	6	52	38
513431	TR-26	7	39	29
518943	TR-41	7	47	36
515642	TR-61	7	51	40
514870	TR-81	7	59	45
524005	VFT-25	4	27	22
524007	VFT-40	4	28	22
524009	VFT-60	4	34	25
524011	VFT-80	4	40	30
524002	VFT-100	4	40	30
523556	VFT-140	4	55	40
523399	VFT-250	4	55	40
523400	VFT-340	4	73	60
523446	VFT-500 A	4	73	60
523447	VFT-500 B	4	73	60
513455	VLT-10	6	31	20
513702	VLT-15	6	39	24
513431	VLT-25	6	39	24
518943	VLT-40	7	47	35
526344	VLT-60	7	47	35
526886	VTA-80	4	52	38
525977	VTA-100	4	52	38
525421	VTA-140	4	52	38
522716	VTE-3	4	16	12
507051	VTE-6	4	14	12
523474	VTE-8	4	17	12

IONIX STATIC ELIMINATOR

The Ionix Static Eliminator



Eliminating static in equipment feeders results in consistently FASTER feeding! Install the Ionix Static Eliminator in your feeder air line and paper static disappears! Higher equipment speeds - less paper waste. Works on sheetfed presses - folders - collators.

New Technology - The Ionix Static Eliminator utilizes a unique means of neutralizing static which has been recognized by the award of US Patent 5,402,304 by the US Patent Office.

Reliable, Safe, Automatic Operation - The Ionix Static Eliminator requires no electricity or maintenance. Simply install the unit in the feeder air line and it works automatically. When exhausted, the Ionix can be disposed in normal waste and recycled with plastics. It contains NO hazardous materials.

Easy to install - Anyone can install the Ionix Static Eliminator in less than 10 minutes on any air line. Simply cut the main blow line between the feeder pump and the feeder and push the hose ends over the barbed nipple ends of the unit. Installation is complete!

How Ionix works in your machine - Ionix makes the blower air going to the paper in the feeder a static eliminator! When blower air passes through the Ionix Static Eliminator, the air is made electrically dissipative. When that Ionix treated air is then blown between the sheets of paper, the static charged sheets discharge through the Ionix air and the sheets separate. Static is gone!

Ionix is unconditionally guaranteed!

Ionix unconditionally guarantees the Ionix Static Eliminator for 30 days. If you are unsatisfied, return the Ionix within 30 days for a full refund. Ionix is warranted for 6 months and replacement is recommended after 1 year.

Ionix is easy to install

Follow this easy 2 step process for sheet fed presses and folders:

1. Identify the MAIN feeder blow air line and measure its inside diameter.
2. For presses and folders with sheet size up to 22" by 34" AND blower hose with:

- 1/2" inside diameter - Model 200-2
- 3/4" inside diameter - Model 200-3
- 1" inside diameter - Model 200-4
- 1 1/4" inside diameter - Model 200-5
- 1 1/2" inside diameter - Model 400-6
- 1 3/4" inside diameter - Model 400-7
- 2" inside diameter - Model 400-8



For presses and folders with sheet size over 22" by 34" and up to 26" x 40" AND blower hose with:

- 1/2" inside diameter - Model 300-2
- 3/4" inside diameter - Model 300-3
- 1" inside diameter - Model 300-4
- 1 1/4" inside diameter - Model 300-5
- 1 1/2" inside diameter - Model 400-6
- 1 3/4" inside diameter - Model 400-7
- 2" inside diameter - Model 400-8

Call for sizing for presses over 1000mm wide, collators, binders, sheeters, laminators, diecutters and other equipment or if you are feeding plastic sheets.

SPRAY POWDER

Oxy Dry: Uncoated, Coated

Oxy Dry Spray Powder

Uncoated

Type	Micron Size	Description
OXY15	15	Smallest particle size available. Comprised of specially-treated cornstarch for use where a light form and second pass work is necessary.
OXY20	20	Where excellent results are required for medium to heavier forms.
OXY26	26	Wide acceptance, particularly where a 40" or smaller press is used; results in a smooth finish.
OXY36	36	For ultimate offset protection and smoothness of sheet for the folding carton, record jacket printer. A versatile powder.
OXY48	48	Provides printer with maximum control of dispersion rate—an all-purpose powder.
OXY52	52	Optimum performance for excellent results on cartons (e.g. ice cream) and sul-fite board. Very popular; highly recommended for air/vacuum dusting.
OXY64	64	Designed to handle the functions of both OXY52 (above). In a Larger Powder.

BULBS AVAILABLE FOR OXY-DRY AND ELECTRO SPRAYER

Coated

Type	Micron Size	Description
OXY15-C	15	A coated version of OXY15 for the same use but produces a smoother sheet. Compatible with varnishing.
OXY20-C	20	A coated version of OXY20, for the same uses as OXY20 but produces a smoother sheet. Compatible with varnishing.
OXY26-C	26	The world's most widely used powder; finds application on every press from 78" to Multiliths. Electrostatic and airborne dusting.
OXY34-C	34	Coated blend for use where smoothness is a requirement.
OXY46-C	46	Premium quality, can be used as a substitute for all 40-50 micron powders for improved smoothness. Long recognized as the best anti-offset protection.
OXY52-C	52	Coated OXY52, for the same uses as OXY52 but with increased smoothness. Great when varnishing.

New packaging guarantees spray powder will always be fresh.

Oxy Dry Anti-Offset Powder available in 55 lb., 11 lb. boxes and 2.2 lb. pouches.



ANTI-STATIC, ANTI-MARKING

Anti-Marking, Anti-Static Systems

SUPER BLUE 2^{LT}™

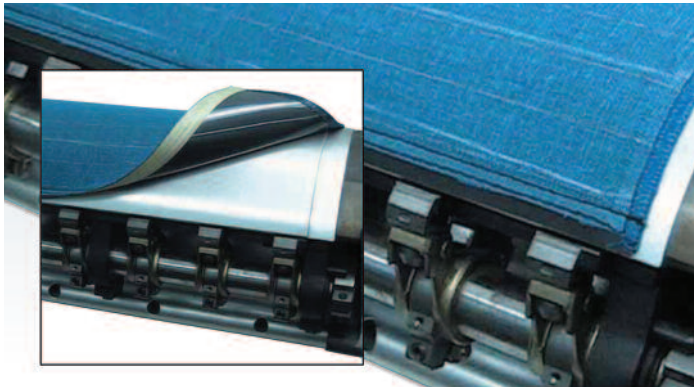

All the features of a SUPER BLUE 2 LT® system in a fully integrated, disposable anti-marking, anti-static kit designed specifically for today's high quality and fast paced demands. No more net adjustments. No more net replacements. The SUPER BLUE 2^{LT}™ system incorporates the STRIPENET® anti-marking net and the base cover into a single integrated piece. Simply remove and replace when needed.



The patented SUPER BLUE 2® anti-marking, anti-static system featuring STRIPENET® anti-marking, anti-static nets is a superior method of protecting the wet side of a printed sheet. It accomplishes this by preventing ink build up on transfer and delivery positions, thus eradicating the common problem of marking.

Anti-Marking Films

BLUE GLASS™



When it comes to protecting the wet side of the printed sheet using textured surfaces, nothing out-shines BLUE GLASS™ anti-marking film. The unique construction of BLUE GLASS™ anti-marking film reduces marking problems associated with ink/coating build up on the surfaces of the transfer positions. Available in micro bead, small bead, and large bead grades of adhesive or non-adhesive rolls, cut sheets and jackets.

Anti-Marking, Anti-Static Nets

STRIPENET®

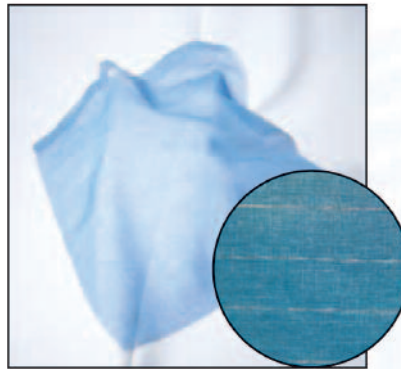

SUPER BLUE 2® StripeNets® anti-marking, anti-static nets are chemically treated non-stretchable, wrinkle-free fabric, which eliminates any maintenance of the net. A soft metallic fiber woven into the net at regular intervals are conductive which helps reduce static electricity build up between printing units. These lines also serve as guides

enabling an easy and trouble-free installation process. Available in precision sizes for most press models and sizes and generic cuts for custom fits.

Anti-Marking Nets

SUPER BLUE® Original with Stripe

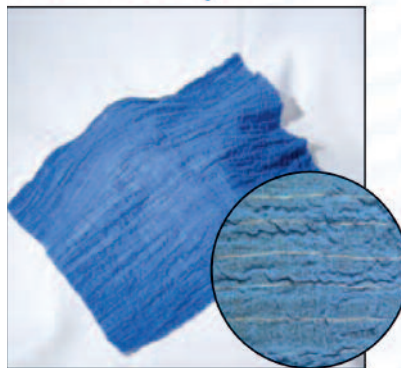

SUPER BLUE® Original with Stripe anti-marking nets are a chemically treated stretchable fabric. The net has a soft wrinkle surface and feature a soft metallic fiber woven into the net at regular intervals aiding in installation and maintenance and help reduce static electricity. Available in generic sizes for all press models and sizes.

SUPER BLUE® Original

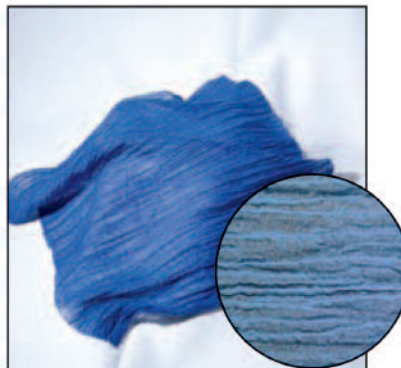

SUPER BLUE® Original anti-marking nets are a chemically treated, stretchable fabric. The net has a soft wrinkle surface. Available in generic sizes for all press models and sizes.

Litho-Perf

The original Boyd product, Litho-Perf, remains the industry standard today for reliability and high-quality performance. It is available in 6-, 8-, 12- and 16-tooth blades with height selections from .0125 inch to .029 inch, allowing you to perform perforations on a wide variety of different paper and card stocks. Used for such jobs as direct response mailing cards, coupon booklets, and raffle tickets.

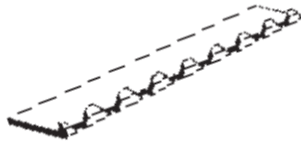

Part#	Description
810	8 tooth paper
811	8 tooth card
812	12 tooth paper
813	12 tooth card
814	16 tooth paper
815	16 tooth card

Litho-Score

The first in-the-run, on-press scoring accessory designed for the offset press, Litho-Score holds consistent register with the printed copy. The rule prepares the stock for a neater fold and is available in various heights for card and paper stocks. Litho-Score is ideal for scoring newsletters, folders, thank-you cards, announcements and table tents.

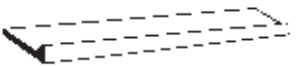

Part#	Description
827	paper

Litho-Score/Card

The new Litho-Score has no sharp, square edges that risk cutting the heavier stocks. Its wider, round scoring edge helps minimize cracking and is excellent for heavy coated and uncoated stock, cast-coated paper, and jobs where scoring over solid coverage is required.

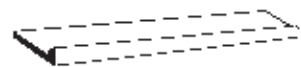

Part#	Description
827-3	card

Litho-Score/CS

A new development for the offset press, Litho-Score/CS has no sharp, square edges that risk cutting heavy stock. Its wider, rounder scoring edge helps minimize cracking and is excellent for heavy-coated and uncoated stocks, cast-coated paper, and many jobs where scoring through solid coverage is required.

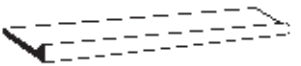

Litho-Perf/CS

Offering the same perforating performance as the standard, side-aligned Litho-Perf, Litho-Perf/CS has center-mounted teeth for increased pressure and longer runs. This is currently the only center-mounted rule available that has been heat-treated using Boyd's time-tested methods for extended life.

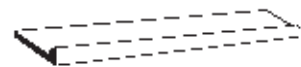

Litho-Snap



Litho-Snap functions in the same manner as Litho-Perf, creating perforated, quick-separation snap-out or snap-apart forms. Available in 3- and 4-tooth blades, Litho-Snap 3-tooth is available only for paper stock.

Litho-Snap functions in the same manner as Litho-Perf, creating perforated, quick-separation snap-out or snap-apart forms. Available in 3- and 4-tooth

Litho-Slit

Litho-Slit eliminated separate runs by permitting on-press straight-cutting possibilities. The blade is effective for slitting, straight-line die cutting and insertion slots in presentation folders and can be used on either card or paper stocks. Litho-Slit can be selected with either a straight knife edge, or a serrated edge to meet specific criteria for cleanness of cut.

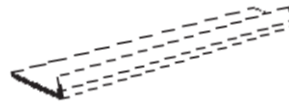

Part#	Description
830	paper
831	card

Litho-Slit/CS

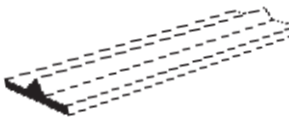

The straight-cut, center-mounted blade performs virtually all types of die cuts and cut-outs more economically than ever, and gives you the added advantage of in-house quality control.

Micro-Perf/SS

With 30-, 40- and 50-tooth blades, Micro-Perf is ideal for perforating continuous-feed forms, offering a perforation line that remains clean. The blades are available in a blade height of .022 inch, designed for use on paper or lightweight card stocks. Use Micro-Perf for jobs that will pass through a laser printer after being perforated.

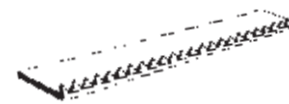

Part#	Description
301	30 tooth
401	40 tooth
501	50 tooth

Litho-Punch



Litho-Punch creates a punched circular cut that remains lightly attached for removal by the end user. Litho-Punch is ideal for making circular punches in promotional pieces or binder inserts. It is available in 1/8", 3/16", 1/4", 3/8", 1/2", 1", 1 1/4", and 1 1/2" diameters, with other diameters available by special order. A serrated or straight-cut edge may be used—available for both paper and card stocks.

Litho-Punch creates a punched circular cut that remains lightly attached for removal by the end user. Litho-Punch is ideal for making circular punches in promotional pieces or binder

Litho-Die

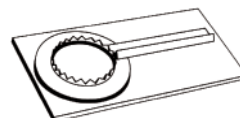

Litho-Dies are designed for die cutting on the offset press. Doorknob, door hanger and window dies are available in a wide variety of sizes, however, we also offer custom dies and a variety of complex shapes. All are mounted on shim stock for ease of attachment, and are heat-treated.

Litho-Dies are designed for die cutting on the offset press. Doorknob, door hanger and window dies are available in a wide variety of sizes, however, we also offer custom dies and a

Digital Packing Gauge



Digi-Blanket Digital Packing & Blanket Gauge - Digi-Blanket is suitable for use only on blanket or aluminum and polyester plates applied to a ferrous substrate and use the magnetic properties of the substrate material to determine the material thickness. Easy to set up & easy to use **Part# PGD**

Precision Pack Hand Held Packing Gauge



In operation, the Precision Pack accurately measures the height of the surfaces of the two cylinders (in thousandths of an inch), and the total of these two heights indicates if the degree of contact is proper. For example, should the plate surface have a height of .001 inches, the total .003 inches, is

within the preferred tolerance. The amount of this total height or impression depends on the type of plate being run, and the distribution of this impression depends on the press manufacturer's specifications. The Precision pack is equipped with a dial indicator calibrated in thousandths of an inch (.001) and is actuated by the vertical movement of the pressure lever. **Part# PG140**

Digi-nip Measuring & Rolling Gauge

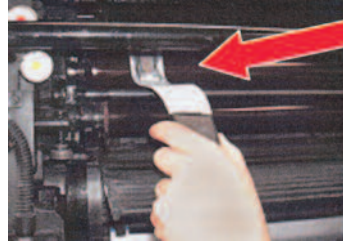

Uses Sensor Strips Technology to provide dual measurements instantly on the Digital Readout Display

Roconex Magnetic Packing Gauge



Improve the quality of your printing - The Roconex Magnetic Packing Gauge is the best instrument available for checking the actual thickness of the packing under the press blanket and plate after they have been placed on the press. Although the packing and blanket thickness

may have been measured accurately by a thickness gauge before placing on the press, the packing will often crush after a few thousand impressions and the blanket to plate pressure will be incorrect. The error must be determined and corrected on the press to assure high quality printing. Thousands of quality conscious companies around the world are using the gauge to ensure top quality and consistent output. **Part# PG360**

DAMPENING COVERS

3M Dampening Sleeves

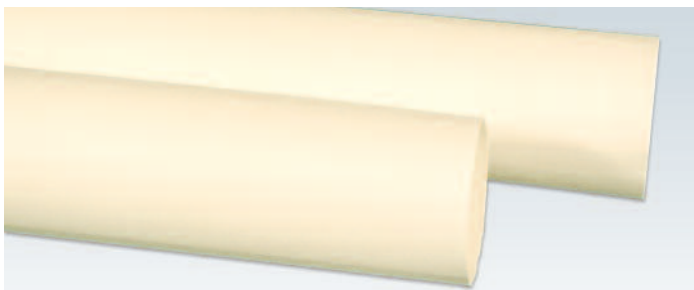

Controlling ink-water balance is key to consistent printing. With Rogers Dampening Sleeves, you'll get that control. Along with the latitude you need for consistent, high quality results on press.

- Precise water control
- Fast and easy installation
- No lint for fast start-ups and cleaner runs
- Starts cleaner. Stays cleaner.
- 50 years in the industry

Product Numbers

13014	20512	21036	25119	26042	31340	36058
18519	20514	22211	25124	27238	31342	39152
18522	20519	22228	25128	27242	32236	42852
18524	20522	22236	25132	28042	33542	42858
18822	20528	23011	25136	29738	33552	44758
19714	21014	23019	25138	29742	33558	
19719	21019	23028	25142	30342	34752	
19728	21022	23032	26038	31336	36044	
19732	21028	24722	26040	31338	36052	

Seamless Dampening Material

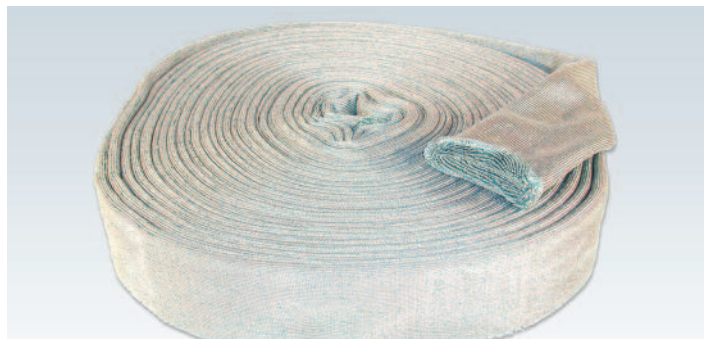

Lint free dampener covers

Our Covers	Competitors	Description
Blue-Boi	Red 1, Green Sleeves, New Mol	Shrink-to-fit, lint free, long life and easy clean up.
Blue Lightning	Hyton, The Shrink Cover	Same as Blue-Boi except thinner cover that allows more room for roller adjustment and carries less water.
Water-Boi	Atex, Seamol, Unidamp	Tightly knitted, dense looped, cotton cover providing highest water absorption
Go-Knit	News-Knit, Hyton Cover,	The most durable cotton cover for newspaper presses.
Litho-Build	Build-Up	Tightly knit, thin cotton cover used primarily on newspaper presses
G-Knit	J-Knit	A cover used over other molleton covers for quick cover change.

Adhesive Polyester Press Packing



Polyester film with a heat resistant adhesive coating on one side. Used to pack the cylinder of the plate and/or the blanket. Ideally suited for applications where an adhesive provides maximum hold during long, high speed operation.

Available with no minimum purchase.

Advantages:

- Accurate Packing
- Dimensionally Stable
- No Swelling
- No Slippage
- Durable
- Reusable
- Decreased Changeover
- Fast Removal
- Easy Clean-Up

Available Thicknesses

.002"	.004"	.006"	.008"	.010"	.014"	.018"
.003"	.005"	.007"	.009"	.012"	.016"	.020"

Non-Adhesive Polyester Press Packing

PPACK NA—custom cut to your sizes



Heat resistant polyester film, non-adhesive press packing is used to pack the cylinder of the plate and/or the blanket. Ideal where the packing needs to be changed frequently. Available in 50 Sheet boxes only and the following gauges:

Available Thicknesses

.002"	.004"	.006"	.008"	.010"	.014"
.003"	.005"	.007"	.009"	.012"	

Kimlon Specialty Press Packing

- Rubber saturated, high bulk compressible paper packing
- Excellent vibration absorption
- Rubber-like resiliency and true volume compressibility
- Immediate and complete bounce-back to original thickness
- Evens out blanket pressures by compressing as needed
- Allows printing to lowest spot on blankets without distortion
- Shock absorption can be 30–60% greater than that provided by compressible blankets alone
- Absorbs cylinder vibrations well to permit faster running specs
- Does not sink or take a set, and is not easily smashed
- Resists water pickup
- Extremely accurate caliper profile



Good option for older presses
 Good solution for rough plants
 Adhesive or non-adhesive back
 Broad caliper range (.008"–.046")
 Custom sheet sizes

Note: To determine the amount of packing paper required, follow the manufacturer's recommendations, as incorrect packing will cause an imbalance of cylinder diameters

Attaining Maximum Print Quality with Sunshine Press Packing

Utility

SunPak is suitable for all web and sheetfed offset applications as well as packaging, forms and letterpress printing.



Sunpack Special Features

Surface smoothness and uniformity helps maintain consistent solids.

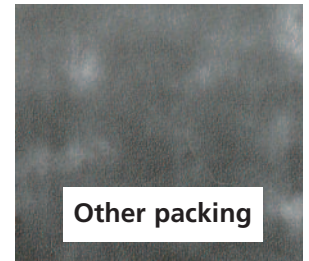

- Helps maintain uniformity of solids
- Helps control print length
- Provides improved registration control
- Saves time
- Reduces costs



Uniform Caliper



Excellent Sheet Density



Improves **Print Consistency**
 Minimizes "Squeeze"
Anti-Slip Controls "Creep"

Mobil and Shell Oil & Greases

The same brands and greases that Heidelberg recommends and supplies with all their presses.



Perma Lube Grease Cartridges



The PERMA Automatic Lubricator self-contained lube system provides bearings and bushings with positive lubrication 24 hours a day. Doesn't need a motor, pump or electric power. Lasts from 1–24 months, depending on the type of injector in use.

Part #	Description
PL6	Perma Lube Cartridge 6 Months (Red)
PL12	Perma Lube Cartridge 12 Months (Grey)
PL24	Perma Lube Cartridge 24 Months (Blue)

Kluber Centoplex GLP500



High pressure fluid grease, thermally stable from 35°–120°F. Recommended by most manufacturers.

Part# KLGLP500

Heidelberg Chain Lube



Part# LA8P

Multi-Lube



A superior external multi-purpose lubricant. A unique blend of Teflon resin and other proprietary ingredients displaces moisture providing rust and corrosion protection. Multi Lube is quick and easy to apply in any area where friction may be a concern. It's PMCC Flash Point of 389°F. and high fire point of 410°F. permits you to apply lubrication in areas where other spray lubricants may fail or be hazardous. No CFCs or propellants!

Part# EM30104 Gallon
Part# EM31606 16 oz.

Press Oil



Premium non-detergent oil fortified with Teflon resin and other properties. The unique Emerald 2000 chemistry lubricates the working metal surfaces, substantially reducing heat, friction and wear. Extreme pressure agents and rust and oxidation properties provide excellent protection against friction, moisture and oil oxidation. Use in equipment that requires ISO VG 32 (10w) oil.

Part# EM4104 Gallon

Emerald 2000 One Step Chain Saver



One of a kind cleaner and lubricant. Dispersant chemistry and Teflon resins dissolve sheet powder residue and lubricate delivery chain within minutes, all in one step! Rust, oxidation and antiwear properties provide long lasting lubrication protection for your chains. During regular maintenance, spray on chains, allow soaking for 15 minutes, using an air hose or wiping it off. Apply a small

amount to the chain periodically to resist future powder buildup. Part# EM10104 Gallon

Grease Gun

Lever style, heavy duty with hose.

Part# GG410



No. 22 Artist Mounting Adhesive Spray



A crystal clear formula that has fast tack. Repositionable, ideal for temporary bonding. Use on paper, cardboard, illustration and mat board, wood, glass, foil, mylar, foam core, acetate and fabric. **Part# SW22**

No. 40 Glass Cleaner



Cleans in seconds. Guaranteed to leave no film, streaks or scratches. Use on copy boards, camera lenses, film negatives, vacuum-frames, stripping tables. **Part# SW40**

No. 45 CRT Terminal Screen Cleaner



Fast-drying. Non-streaking. Cleans and dissipates the electrostatic charge on terminal screens which is the cause of dust attraction and dirt build-up. Non-abrasive and scratchproof. **Part# SW45**

No. 63 C-60 Solvents Cleaner & Degreaser



Removes unwanted ink spots, soil, grease, machine oil and other troublesome stains fast. Leaves no ring. **Part# SW63**

No. 66 Spray Adhesive



Quick tack. Long tack. Non-wrinkling. Water-resistant. Creates a pressure sensitive surface for temporary or permanent bond. Excellent for mounting printing plates. Leaves no adhesive on machine. **Part# SW66**

No. 77 Silicone Lubricant



Economy "semi-wet" silicone spray and release agent for easy flow to penetrate hard-to-reach areas, eventually drying for clean results. Stops rust and produces slick surfaces. **Part# SW77**

No. 87 Super Tack Adhesive



General purpose mist adhesive - non staining formula - ideal for many lightweight bonding applications. Fast tack-high solids. **Part# SW87**

No. 88 Multi-Purpose Spray Adhesive



Fast-drying, heat and water-resistant. Ideal for use on a variety of surfaces. Permanent or temporary bonds. Conforms to ASTM D-4236. **Part# SW88**

No. 90 RD-90 Machine Maintenance Spray



Lubricates, penetrates, displaces moisture, prevents rust. Fine, thin coating keeps moving parts and operating mechanism operating smoothly. Contains no silicone. **Part# SW90**

No. 101 TFE Dry Lubricant



A multi-purpose non-silicone lubricant release agent for check printing, rubber or plastic printing plates. Colorless, reduces friction. **Part# SW101**

No. 201 Plastic Spray Clear Fixative



Protects artwork, photographs, proofs, layouts, blueprints from smudge, smear, grease and moisture. Contains UV protectant. Ideal as an ink jet laminate spray and protective coating for frames to prevent ink build-up and ease maintenance. **Part# SW201**

No. 203 Rubber Cleaner & Rejuvenator



Returns life to ink-laden, hardened rollers and blankets. Restores velvety-smooth surface. **Part# SW203**

No. 204 Matte Fixative



Odorless, clear, permanent, water-proof protection. Dries in seconds to a matte finish which may be worked over. Use on pastels, charcoal, chalk, pencil, ink, water colors and casein. **Part# SW204**

No. 205 Film Cleaner



Cleans film positives or negatives. Removes fingerprints, tape marks, adhesives, grease pencil, ink, lint, dirt and smudges. Leave no residue; quick-drying. **Part# SW205**

No. 206 Specialty Film Cleaner



Cleans diazo film, silver film, color transparencies, screen tints, scanner drums, contact screens. Leaves no residue. **Part# SW206**

No. 715 White Grease



Highly-concentrated, heavy-duty lithium lubricant spray. Leaves long-lasting film. Won't wash away or run off. **Part# SW715**

No. 804 Lint & Dust Remover



Jets of pinpointed moisture-free air clean lenses, film, light tables, etc. **Part# SW804**

No. 805 Clean Jet 100



Non-flammable, ultra-filtered dust remover w/jet accuracy delivers up to 100 psi at 68°F. (20°C.). Cleans small, tight areas in office and computer equipment. **Part# SW805**

No. 945 Silicone Release Agent



Stops sticking and lubricates screen frames, vacuum beds and printing plates for easy printing on various substrates. Dries instantly. **Part# SW945**

No. 949 Ink Anti-Skin



Delays drying of inks in screens. Eliminates screen wash-ups during breaks. Stops ink skinning when sprayed in cans. **Part# SW949**

No. 950 Ink Anti-Skin, No Wash-Up Spray



Eliminates wash-ups. Spray in the ink can to stop skinning. Spray all rollers (while running) and ink fountain. **Part# SW950**

No. 955 Anti-Static Spray



Spray on metal roller, feed-boards, feed arms, cylinders, rollers, drive belts, any place static may generate. **Part# SW955**

RGS Lube Clean Open Frame Compound



Lube Clean is an Open Frame Compound designed to prevent friction burn-up of ink rollers on idle units of multi-unit presses running without ink. Lube Clean also performs as a mild cleaner that gently removes deposits from the roller surface without swelling or damage to the rubber. Lube Clean will not harm plates and blankets. Works with conventional or UV ink. **Part# LC811**

C.P.R. / Roller Cleaning Paste



An invaluable aid for roller cleaning, not only for quick color changes, but to condition rollers by removing ink, glaze and calcium deposits. SUPER CLEAN penetrates into roller pores to deep clean, leaving no residue. Permits color changes from dark to light with a minimum of effort and time. Regular use of SUPER CLEAN helps to condition your rollers

against loss of elasticity in the rubber, thus prolonging roller life. 2.1lb. **Part# RC910**

RGS Liquid Roller Cleaner



RGS Liquid Roller Cleaner (qt) - Deep cleans and deglazes in one application. - Excellent for color changes. - Easy to apply, just squirt it on and let it run.

Part# LIQROL

RGS Chrome Roller Cleaners



RGS Chrome Roller and desensitizer. Removes inks and debris. Long Lasting.

Part# CRD

Putz Pomade



Roller and blanket cleaner removes glaze, restores velvety texture to rollers.

Available in liquid and paste.

Part# PPL13 Liquid Flow

Part# PP416 Paste (15 oz)

Sterling Perfect Print — No Offset Varnish



- Eliminates offset, sticking and picking
- Does not change color of the ink
- Works with all color or metallic inks
- Permits more color with safety
- Does not kill the gloss
- More coverage per pound of ink
- Won't crystallize or dry on press or rollers

Part#	Description
PP516	Perfect Print (quart)
PP5163	Perfect Print (gallon)

Master Anti Dry Spray



Prevents ink from skinning in the ink fountain on blankets and rollers. Also used to spray on ink containers to eliminate waste when can is reopened. Leaves no greasy residue.

Part# ANTIDRY 2

Clean-It All Purpose Pressroom Cleaner



Concentrated detergent and degreaser.

Part# CD6-1

RGS Press Wash

Part#	Product Name	Description
N266	RGS Super N-266 Press Wash	Premium, water-miscible wash for sheetfed and web. Special blend of solvents and emulsifiers. Recommended to use to eliminate the build up of paper lint.
PREMWASH	RGS Premium A Wash Auto Wash	Premium, water-miscible wash for automatic blanket wash
MRCQ	RGS Metering Roller Clean	Premium MRC, fast drying



Nova Fountain Solutions

Part#	Product Name	Description
FS-651-275	Nova Fount FS-651	Neutral fountain solution with zero VOC for newspaper printing.
FS-803	Nova Fount FS-803	Acid fountain solution for offset lithography.

Nova Press Wash

Part#	Product Name	Description
N-230	Nova N-230 Non water Miscible Wash	Non water miscible wash for use when water-miscibility is not required. Use in conditions such as roller stripping, plate blinding and fountain contamination from surfactant build up.
N-251	Nova N-251 Step One Wash	Special emulsion of solvents emulsifiers and water. Deep cleans ink and press contaminants from ink train rollers. Use in conjunction with Nova N-230, as the step two, to thoroughly rinse wash and residue from the rollers
N-333F	N-333F FOGRA approved Blanket and Roller Wash Mild/Vanilla	Based on wash formulas most recommended by European press manufacturers. Flash Point of 142F. Very mild odor. Contains an anti-corrosive agent with no aromatic hydrocarbons. Water miscible with special ink cutting rinseable formula. Has FOGRA approval.
N-340UV	Nova N-340 UV Press Wash	UV, EB & Hybrid ink wash. Aromatic and aliphatic-free; non-damaging to EDPM. Also for hybrid composite and buna-nitrile roller compounds.
N345	RGS N-345 UV Press Wash	Strong UV, hybrid and conventional ink wash for nitrile and composite rollers.
N360-UVA	Nova N360 UVA Wash	UV, EB & Hybrid ink wash for automatic washer systems. Aromatic and aliphatic-free; non-damaging to EDPM, buna-nitrile roller compounds. 165° F flash point.
N-410	Nova N-410 Press Wash	FOGRA approved (pending) VOC wash for Elettra and Baldwin autowash systems. Recommended for multiple web width users.

Nova Silicone Emulsions

Part#	Product Name	Description
S-313	Nova Silicone S-313	Pure non-ionic; 30% active silicone. Compatible with antistatic additives.
S-315A	Nova Silicone S-315A	Non-ionic with built in antistatic agent. 30% active silicone solids.
S-330	Nova Silicone S-330	Hybrid silicone and wax. Use in demanding print conditions to replace more costly 60% silicones. Optimum antimarking with controlled slip in delivery and stackers.
S-347	Nova Silicone S-347	Blend of silicone and a special additive to inhibit the dimensional stretching effect from the absorption of water on the web.
S-511	Nova Silicone S-511	Pure non-ionic. High in silicone solids for excellent performance at low dilution levels.
S-525A	Nova Silicone S-525A	Non-ionic with built in antistatic agent. 50% active silicone solids.
S-557	Nova Silicone S-557	Pure non-ionic, silicone web anti-marking solution for web printing high in silicone solids for excellent performance at low dilution levels.
S-201	Nova Silicone S-201	Antistatic silicone additive for web. Compatible with all of Nova silicone emulsions. Concentrated so usage requirement is usually at 1-4% of working solution.

RGS Fountain Solutions

Part#	Product Name	Description
RAS1	RGS Premium RAS1 Alcohol Sub. Part B	Alcohol substitute with non-piling additives.
RAS2	RGS Premium RAS2 Alcohol Sub. Part B	Alcohol substitute with low odor.
RFS1	RGS Premium RFS1 Fountain Solution Part A	Sheetfed fountain solution that stimulates the drying of sheetfed inks.
RFS2	RGS Premium RFS2 Fountain Solution ONE STEP	One-step acid fountain solution for high quality lithography.
RFS3	RGS Premium RFS2 Fountain Solution Part A	Mild acid fountain solution for sheetfed printing.
RFS4-55	RGS News Fount 689 Mild Acid (55 gal)	Mild acid fountain solution for web offset lithography.

Brush/Conventional Web Dampening Fountain Solutions

Part#	Product Name	Description
2834	AMV	Most waters. Tech limit phosphorus.
2399	DFS-201	Zero VOC. Brush dampening for thermal CTP plates.
2908	Emerald AMVP	High phosphate with good desensitizing for PDI and thermal CTP plates.
2961	Emerald BPQ	Large buffer for all but extremely hard water.
20105	Emerald KDMJ	Works well with conventional and computer to plates.

Continuous Dampening Web Fountain Solutions

Part#	Product Name	Description
2234	Emerald Premium LEH	Passes TEC limit on phosphate.
2837	Emerald Premium MX3Z	Zero phosphates.
2150	Emerald Premium WCNP	Contains extra non-piling ingredients.

Duplicator Fountain Solutions

Part#	Product Name	Description
2912	Emerald Premium MXEH	All waters. Eliminates blinding on aqueous plates.

Newspaper Fountain Solutions

Part#	Product Name	Description
2830	Aqua Magic	Original, top-selling neutral.
20015	Aqua Magic 2000	Maximum performance on subtractive plates.
2080	News Etch 505	Mild acid fount for spray dampening.
2396	News Etch 505 DP	Low VOC neutral solution developed for quality four color process printing on high speed presses

Single-Part Fountain Solution for Sheetfed/Small Web Presses

Part#	Product Name	Description
2941	PAQ	All waters. Contains phosphates and eliminates binding on aqueous plates
20005	PAQ-P	Special formulation for polyester plates



Two-Part Fountain Solutions for Use With Alcohol Substitutes

Part#	Product Name	Description
2077	Emerald JRB	Zero VOC and non-HAPs. For all conventional & CTP plates.
2173	Emerald JRNC	For soft or de-ionized water; used to reduce calcium salt buildup on blankets, rollers and plates
2637	Emerald JR	Deionized to soft water.
2964	Emerald JRZ	Soft to medium water. Helps control calcium.

Anchor Alcohol Substitutes

Part#	Product Name	Description
2873	ARS-JP	Best for Dahlgren type dampening.
2013	ARS-ML	Recommended for Heidelberg Alcolor dampeners.
2597	ARS-WL	Non-HAPs. Safe for all CTP plates.
20179	ARS-SV	Contains no HAPs and offers a wide ink/water balance to help reduce make ready time.

Anchor Fountain Additives

Part#	Product Name	Description
7023	Be Done	Eliminates foam in all recirculating dampening systems.
2438	Gum Arabic 14 Baume	100% pure. Finest quality gum arabic available.
7057	Ink-Ayde	Reduces ink drying time.
7116	Non-Piling Additive	Reduces piling and extends frequency of blanket wash-ups.

UV Washes

California UV Wash

California UV Wash specially formulated to work with EPDM roller and blanket compounds does not contain any petroleum hydrocarbons and has a mild odor with a high flashpoint.

Infinity Wash HMK UV

FOGRA Approved Wash for UV and EB Inks. The product features excellent cleaning power and a mild odor.

UV Wash 100 Plus

Deep cleaning wash for both UV and hybrid inks. Has a controlled evaporation rate with a high flashpoint and is water miscible. Will not harm EPDM compounds.

Specialty Washes

Super Wash Step One & Step Two

SuperWash Step One is a non-separating, viscous water/solvent/detergent blend that, when applied to rollers, actually extracts every bit of ink pigment from the pores of the rollers. Super Wash Step Two is specifically formulated to thoroughly rinse Step One and the extracted ink.

Metering Roller Cleaners

Meter Clean

Fast drying cleaner for continuous dampening systems and other dampening rollers. Thoroughly cleans the rollers in the dampening system to help prevent any ink or resin buildup that can feed back into the dampening system.

Tower MRC

Fast drying metering roller cleaner formulated to clean metering rollers in continuous dampening systems, cleans and evaporates quickly leaving no residue.

Press Specialties

Restorkleen

Deglazer-rejuvenator-conditioner for rollers & blankets. Restorkleen will actually pay for itself in extended rubber life by not only stripping glaze, but restoring plasticizers to rubber surfaces to condition and prevent dehydration. Once-a-day application is all that is needed.

Great Plate!

Plate cleaner and scratch remover will help you minimize press downtime and maximize print quality by rapidly cleaning and conditioning all metal plates. As it cleans removes scratches, oxidation spots, and gum streaks and will make the plate image area more ink receptive.

On The Fly Plate Cleaner

Non-emulsion plate cleaner for baked plates used to clean baked printing plates in a production setting. The product quickly and effectively desensitizes scratches while the web press is running.

WEB Conditioner

Super, antistatic web conditioner that can significantly lower the cost of standard silicone emulsions by using a reduced

dosage. Provides excellent performance at high speeds with no marking, streaking or static, even on light stocks.

Deluxe Calcium Rinse

Calcium roller cleaner formulated to dissolve calcium deposits not just on the surface of the rollers, but deep down into the rubber itself. Emulsifies calcium on contact and can be rinsed away with a water follow up.

Low VOC Washes

Lo-Vo Wash 3.5 WM

Quick drying low VOC press wash with an accelerated evaporation rate. Contains less than 3.5 pounds per gallon of VOC's with excellent cleaning power! Has a mild odor and can be mixed with up to 50% water to further reduce VOC's.

Lo-Vo Wash CA-100

Designed to be used in automatic blanket washer systems on sheet-fed and web presses and earned a FOGRA and Heidelberg approval. Features a strong cleaning action with no residual surfactant residue to contaminate the spray bars or the blankets and it complies with rule 1171 for southern California. A high flashpoint and no reportable hazardous ingredients make this product unique in the industry. Can also be used as a hand wash in all applications.

Lo-Vo Wash EIT-30

For use in Elettra sheet fed and web automatic blanket washer Systems designed to be used in automatic blanket washer systems on sheet fed and web presses. Features a strong cleaning action with no residual surfactant residue to contaminate the spray bars or the blankets. Lo-Vo Wash EIT-30 has a high flashpoint and a VOC content of 30%.

Lo-Vo Wash 2000 Automatic QW

Designed to be used in automatic blanket wash systems without the use of a water rinse. Features a strong cleaning action without residual surfactants that may clog washer spray bars. Lo-Vo Wash 2000 Automatic QW has a flashpoint of 150 degrees f. and a VOC content of 30%. Approved for use in oxy-Dry, Elettra and Heidelberg Harris automatic web cleaning systems.

Sheetfed Fountain Solutions

Millennium SF

High technology fountain solution formulated to run well with difficult dampening systems, especially the Alcolor dampener. In conjunction with our outstanding alcohol replacements, allows the printer to reduce roller speeds and decrease ink consumption. Well suited for soft to medium water and is buffered to run an expected ph of 3.8-4.2 for fast roll-ups. Tested and approved by major plate manufacturers for compatibility with CTP materials. Also works with conventional, hybrid and UV ink systems. Works best with the following Tower Alcohol replacements: Dynamic ARP and AR-7500.



Millennium 7000

Sheet fed fountain solution with calcium control is a high technology fountain solution formulated to run well with difficult integrated dampening systems. Has a unique buffering system that helps to prevent calcium deposits. In



conjunction with AR 7500, allows the printer to reduce water roller speeds and obtain the best possible ink/water balance. Does not contain any HAP's and is free of VOC's. Compatible with UV, hybrid, Metallic and conventional inks since it does not contain any glycol materials.

Millennium One

One-step sheet fed fountain solution contains a unique package of wetting agents and alcohol replacements for sheet fed printers desiring a one-step system. Shown remarkable results and at lower dosage rates than competitive products, saving you money on the product and on chemically attacked rollers! Tested and approved on CTP materials.

Millennium 1000

Premium, one-step fountain solution that does not require the addition of alcohol or alcohol substitutes to the fountain. Formulated to run metal plates on all types of dampening systems. Can effectively replace traditional one step products in most applications at a lower dosage.

Millennium Silver

Polyester and laser plate fountain solution contains a new generation of custom wetting agents and buffers to keep the plate clean and prevent toning. Can also be used for metal plates in short run situations, approved for use by Xante and Auto-type.



Web Fountain Solutions

Millennium DGT

One-step CTP web fountain solution designed for web presses utilizing CTP technology. Features a unique wetting technology and strong buffering system and will work on both brush and integrated dampening systems. Helps to prevent ink feedback to the dampening system and provides fast rollups without plate blinding. Designed to maximize the performance of web presses using CTP plates, but the product also works very well with conventional plates.

Millennium HSW-100

High speed, heatset web fountain solution has a strong buffering system and will work well in various types of dampening systems to provide fast, clean restarts. Designed to maximize the performance of printers running CTP plates and will run in lo to medium hard waters. Formulated specifically for new high speed heatset web presses.

Water Miscible Washes

I.P. Wash

Economy low odor water miscible wash will quickly remove ink and varnish with a light pleasant odor and plenty of cleaning punch. Can be mixed with water up to 30% for even more economy. Ideal product for automatic blanket washers and is approved for use in Baldwin and other automatic units.

Colorkleen42

Citrus scented water miscible wash has a moderate evaporation rate and can be mixed with up to 30% water. This operator-friendly product is at home in the smallest duplicator shop as well as the large format sheet fed plant.



Shortstop

One-step water miscible wash is an outstanding value since it cleans better than most competitors' premium products at a better price! Features excellent water miscibility (up to 30%) and an almost odorless formula.

Press Pro

Premium water miscible wash for printers who demand the very best, Press Pro is the finest water miscible wash we make. Contains a unique package of high technology cleaning agents, conditioners and deglazing compounds for thorough deep cleaning action. Can be used straight or be mixed with up to 50% water for maximum economy and VOC reductions.



Star Wash

High flashpoint water miscible wash formulated for printers that require solid cleaning power but a flashpoint over 142 degrees F. Features a low odor and a water miscible link that creates a thin film emulsion when mixed with up to 30% water. Perfect product for solvent recovery systems on Heidelberg presses and other spray cleaning systems.

W.O.W. - Exempt-WM

Non-photochemically reactive press wash is formulated to help printers in non-attainment air quality areas to comply with photochemical clean air regulations. Features excellent cleaning power, is water miscible up to 30% and will not harm most of today's modern rubber roller compounds.

Infinity Wash HMK-1 WM

FOGRA approved auto wash has passed the rigorous testing of the German testing agency FOGRA. Approved for use in the sheet fed auto wash systems of Heidelberg, MAN Roland and KBA. Water miscible and aromatic free with a very low odor.

Tech Wash IF

One-step water-miscible roller and blanket wash is a highly effective wash that will quickly remove ink and varnish. Water miscible, will also remove gum, glaze, paper, lint and other water soluble compounds. Excellent choice for automatic blanket wash systems.

Alcohol Replacements

Dynamic ARP

Alcohol replacement formulated to dramatically lower surface tension of press ready fountain solution. Superb wetting agent and water conditioner, can be used at lower dosage ratios versus traditional alcohol replacements. If used in combination with our fountain solutions, highly effective on difficult to run dampening systems. Tested and approved for CTP plates.

AR-7500

High technology alcohol replacement designed to increase the viscosity of water when used in continuous dampening systems. Does not contain any HAP's and will not damage unbaked CTP plates. When used with Tower fountain solutions, it provides the optimum ink water balance for outstanding press performance. When used with Millennium 7000, it provides an outstanding solution for UV printing and printing on non-porous substrates like plastic.

Horizontal Drum Storage

Door Type	Capacity	Ext. Dimensions		Approx./Lstg. Regulation	Model No
		H x W x D			
2 dr., manual	55 gal.	50" x 30" x 48"		N, O	899300
2 dr., self-closing	55 gal.	50" x 30" x 48"		N, O, U	899320

Approv./Lstg.-Regulation Key	
FM-	Factory Mutual tested and approved.
UL-	Underwriters Laboratories listed.
N-	Designed in accordance with specifications set forth in the National Fire Protection Association (NFPA) Code 30.
O-	Complies with OSHA regulations.
U-	Complies with Uniform Fire Code.

Yellow Vertical Drum Storage Cabinets

Number of Doors and Style	Drum Cap. (Gallons)	Drum Cap. (Liters)	Ext. Dim. HxWxD (inch)	Ext. Dim. HxWxD (mm)	Approv./Lstg. Regulation	Sure-Grip® EX Yellow Model No.
2 door, manual	1-55	200	65 x 34 x 34	1651 x 864 x 864	FM, N, O	896200
2 door, self-close	1-55	200	65 x 34 x 34	1651 x 864 x 864	FM, N, O, U	896220
2 door, manual	2-55**	400**	65 x 59 x 34	1651 x 1498 x 864	N, O	899100
2 door, manual with drum rollers	1-55	200	65 x 34 x 34	1651 x 864 x 864	FM, N, O	896260
2 door, self-close with drum rollers	1-55	200	65 x 34 x 34	1651 x 864 x 864	FM, N, O, U	896270
2 door, manual with drum rollers	2-55**	400	65 x 59 x 34	1651 x 1498 x 864	N, O	899160
2 door, manual with drum rollers	2-30**	220	65 x 43 x 34	1651 x 1092 x 864	FM, N, O	899060
2 door, self-close, drum support	2-55	400	65 x 59 x 34	1651 x 1498 x 864	N, O, U	899120
2 door, self-close, drum rollers	2-55	400	65 x 59 x 34	1651 x 1498 x 864	N, O, U	899170
2 door, self-close with drum rollers	2-30	220	65 X 43 X 34	1651 X 1092 X 864	FM, N, O, U	899073



899300



899100

Safety Can Storage

Door Type	Capacity	Ext. Dimensions H x W x D	Adj. Shelves	Approv./Lstg. Regulation	Model No.
2 dr., manual	30 gal.	44" x 43" x 18"	1	FM, UL, N, O	25300
2 dr., self-closing	30 gal.	44" x 43" x 18"	1	FM, N, O, U	25302
4 dr., manual	30 gal.	44" x 43" x 18"	1	N, O	25304
2 dr., manual	30 gal.	35" x 36" x 24"	1	FM, N, O	25330
2 dr., manual	45 gal.	65" x 43" x 18"	2	FM, UL, N, O	25450
2 dr., self-closing	45 gal.	65" x 43" x 18"	2	FM, N, O, U	25452
4 dr., manual	45 gal.	65" x 43" x 18"	2	N, O	25454
2 dr., manual	60 gal.	65" x 34" x 34"	2	FM, N, O	25600
2 dr., self-closing	60 gal.	65" x 34" x 34"	2	FM, N, O, U	25602
2 dr., manual	90 gal.*	65" x 34" x 34"	2	FM, N, O	25860
2 dr., self-closing	90 gal.*	65" x 34" x 34"	2	FM, N, O, U	25862
sliding dr., self-closing	30 gal.	44" x 43" x 18"	1	FM, N, O, U	25530
sliding dr., self-closing	45 gal.	65" x 43" x 18"	2	FM, N, O, U	25545

* These models are also covered under New York City approval No. 4448



25450



25300, 25452



25302

Yellow Double-Duty Safety Cabinets

Number of Doors and Style	Drum Capacity (Gallons)	Ext. Dimensions H x W x D (inch)	Ext. Dimensions H x W x D (mm)	Adjustable Shelves	Approv./Lstg. Regulation	Model No.
2 door, manual, drum rollers	155	65 x 59 x 34	1651 x 1498 x 864	3	N,O	899160
2 door, self-close drum rollers	155	65 x 59 x 34	1651 x 1498 x 864	3	N,O	899120

Accessories for Drum Storage Cabinets

Description	Dimensions L x D (inch)	Dimensions L x D (mm)	Model No.	Sure-Grip® EX Model No.
Steel half-depth shelf for single 55 gallon vertical drum cabinet	30.375 x 14	771 x 356	25906	29946
Steel half-depth shelf for double 55 gallon vertical drum cabinet	55.375 x 14	1407 x 356	25929	29947
Drum roller for single 55 gallon vertical drum cabinet	29.5 x 30	749 x 762	25920	-
Drum roller for double 55 gallon vertical drum cabinet	55.5 x 30	1410 x 762	25922	-
Drum roller for double 30 gallon vertical drum cabinet	37 x 30	940 x 762	25923	-
Drum Cabinet Ramp	28 x 24.5	711 x 622	25932	-



896260

Type I Red Safety Cans for Flammables

Description and Capacity	Dimensions Outer Dia. x H (inch)	Dimensions Outer Dia. x H (mm)	Approv./Lstg. Regulation	Model No.
1 pint (0.5L) steel safety can	4.375 x 6.75	117 x 172	FM,UL,ULC	10001
1 quart (1L) steel safety can	4.375 x 8.25	117 x 210	FM,UL,ULC	10101
1 gallon (4L) steel safety can	9.5 x 11	241 x 279	FM,UL,ULC	7110100
2 gallon (7.5L) steel safety can	9.5 x 13.75	241 x 349	FM,UL,ULC	7120100
2 gallon (7.5L) steel safety can with 11202Y funnel	9.5 x 13.5	241 x 343	FM,UL,ULC	7120110
2.5 gallon (9.5L) steel safety can	11.75 x 11.5	298 x 292	FM,UL,ULC	7125100
2.5 gallon (9.5L) steel safety can with 11202Y funnel	11.75 x 11.5	298 x 292	FM,UL,ULC	7125110
5 gallon (19L) steel safety can	11.75 x 16.875	298 x 429	FM,UL,ULC	7150100
5 gallon (19L) steel safety can with 11202Y funnel	11.75 x 16.875	298 x 429	FM,UL,ULC	7150110

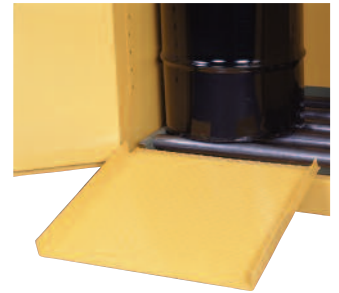

25932

Poly Funnel for Type I Steel Safety Cans

Description	Dimensions Outer Dia. x H (inch)	Dimensions Outer Dia. x H (mm)	Approv./Lstg. Regulation	Model No.
Poly Funnel fits Type I Steel cans	0.5 x 11.25	13 x 286	-	11202Y



25920



7150100

7150110



7110100



7120100

Red Oily Waste Cans

Description and Capacity	Dimensions	Dimensions	Approx./Lstg. Regulation	Model No. Red	SoundGuard™ Model No.
	Outer Dia. x H (inch)	Outer Dia. x H (mm)			
6 gallon (23L) oily waste can with foot operated cover	11.875 x 15.875	302 x 403	FM,UL	09100	09108
6 gallon (23L) oily waste can with hand operated cover	11.875 x 15.875	302 x 403	FM,UL	09110	
2 gallon (8L) countertop oily waste can	9.625 x 9.125	244 x 232	FM	09200	
10 gallon (38L) oily waste can with foot operated cover	13.938 x 18.25	354 x 464	FM,UL	09300	09308
10 gallon (38L) oily waste can with hand operated cover	13.938 x 18.25	354 x 464	FM,UL	09310	
14 gallon (53L) oily waste can with foot operated cover	16.063 x 20.25	408 x 514	FM,UL	09500	09508
21 gallon (79L) oily waste can with foot operated cover	18.375 x 23.438	467 x 595	FM,UL	09700	09708
21 gallon (79L) oily waste can with hand operated cover	18.375 x 23.438	467 x 595	FM,UL	09710	
14 gallon (53L) oily waste can with hand operated cover	16.0625 x 20.25	408 x 514	FM,UL	09510	
14 gallon (53L) oily waste can with hand operated cover	16.0625 x 20.25	408 x 514	FM,UL	09510	



09100

Plunger Cans

Description and Capacity	Dasher Assembly	Plunger Assembly	Dasher	Dasher	Dimension	Dimension	Approx./Lstg. Regulation	Red	Yellow
			Dia. (inch)	Dia. (mm)	OD x HT (inch)	OD x HT (mm)		Model No.	Model No.
1 pint (0.5L) steel plunger can	Steel	Brass and Ryton	2.75	70	4.875 x 5.25	125 x 133	FM	10008	10018
1 quart (1L) steel plunger can	Steel	Brass and Ryton	5	128	7.25 x 5.625	185 x 143	FM	10108	10118
2 pint (1L) steel plunger can	Steel	Brass and Ryton	5	128	4.75 x 7.75	121 x 197	FM	10143	10141
2 quart (2L) steel plunger can	Steel	Brass and Ryton	5	128	7.25 x 7.375	185 x 187	FM	10208	10218
1 gallon (4L) steel plunger can	Steel	Brass and Ryton	5	128	7.25 x 10.5	185 x 267	FM	10308	10318
1 quart (1L) nonmetallic plunger can	Brass	Brass	5	128	5.5 x 8.25	141 x 210	FM	14018	-



14018



10208

10308

10008

10143

10108

Nonmetallic Dispensing Cans

Description and Capacity	Dimension	Dimension	Spout	Spout	Approx./Lstg. Regulation	Model No.
	Outer Dia. x HT (inch)	Outer Dia. x HT (mm)	Opening ID (inch)	Opening ID (mm)		
4 ounce (0.12L) nonmetallic dispenser can	2.25 x 5.5	57 x 140	.25	6	-	14002
8 ounce (0.24L) nonmetallic dispenser can	3.125 x 5.5	79 x 140	.25	6	FM	14004
1 quart (1L) nonmetallic dispenser can	4 x 10.5	102 x 267	.25	6	FM	14010



14004

14002

14010



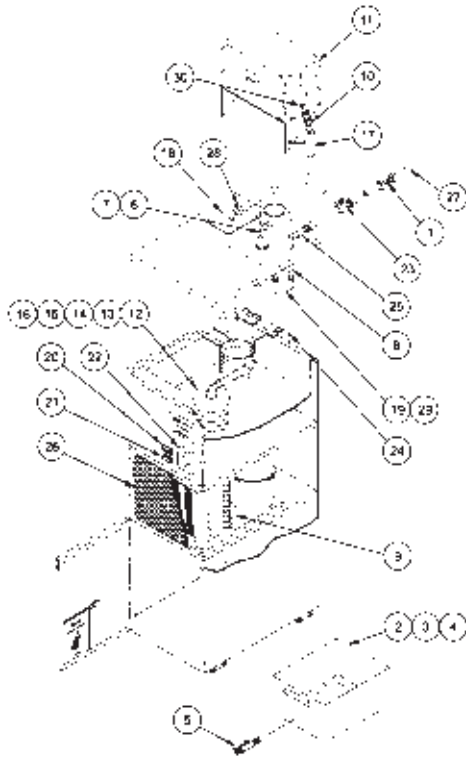

21	9-416-5501-02	Green Lamp - System Power Indicator
22	9-425-1201-01	Power Switch - On/Off (SS5 & 10)
	9-425-1201-02	Power Switch - On/Off (SS20 & 30)
23	9-500-0055-33	Tee - Nylon (1/2" Hose Barb)
24	9-570-0100-03	Thermostat - Manual
25	1-181-0011-01	Shut-Off Valve Assy. (1/2" Barb Both Ends)
26	1-130-0003-01	Filter - Air (10 3/4 x 15 x 1/2" with Frame) (SS5-30)
	1-130-0005-01	Filter - Air (11 1/2" x 12 1/2" x 1 without Frame) (SS5-30)
	1-130-0003-02	Filter - Air (9 3/4 x 14 x 1/2" with Frame) (SS3)
27	9-598-0107-02	Tubing - Clear Poly. (1/2" I.D. x 3/4" O.D.)
28	9-598-5001-14	Clamp - Hose (Tyton SNP-14) 1/2"
29	1-211-0002-01	Impeller Housing - Bottom Half
30	1-180-0040-01	Bottle Cap Assy. With Hose Kit (SS5)
	1-181-0003-01	Plug Assy. - Fill, 5-Gallon Auxiliary Tank (SS5-30)
	1-180-0039-01	Bottle Cap Assy. With Hose Kit (SS3)





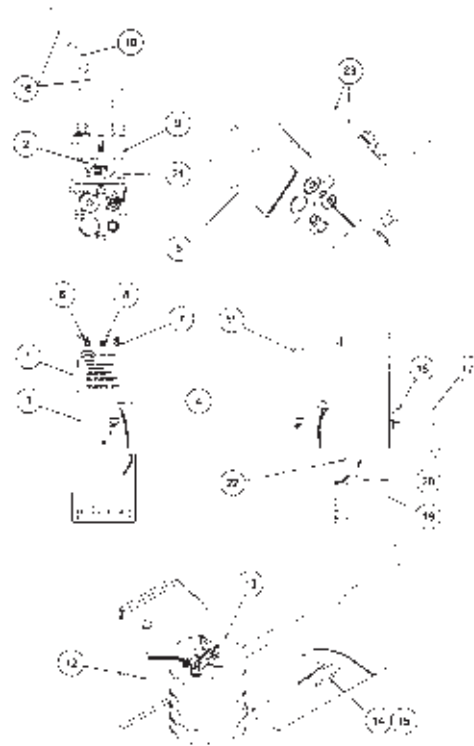

Replacement Parts List (Spacesaver)



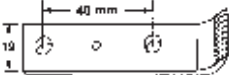

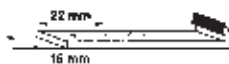
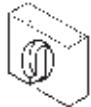

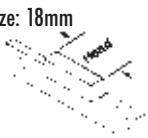

Item	Part Number	Description
1	0-181-0012-01	Valve Assy. - Pan Flow Control 1/2" x 1/2"
	0-181-0013-01	Valve Assy. - Pan Flow Control 1/2" x 3/8"
	0-181-0011-01	Valve Assy. - Pan Flow Control 3/8" x 3/8"
	0-181-0015-01	Valve Assy. - Pan Flow Control 1/2" x 1/4"
	0-181-0017-01	Valve Assy. - Pan Flow Control 1/2" x 5/16"
	0-181-0016-01	Valve Assy. - Pan Flow Control 1/4 x 1/4"
	0-181-0018-01	Valve Assy. - Pan Flow Control 5/16 x 5/16"
2	1-181-0004-01	Valve Assy. - Return Accumulator
3	1-180-0032-01	Accumulator Assy. - Return (with Shut-off valve)
4	1-102-0008-01	Reservoir - Return Accumulator
5	1-181-0011-02	Shut-Off Valve Assy. (1/2" Barb Both Ends)
6	1-280-0015-01	Pump Assy. - Nova PV, 115V
	1-280-0015-02	Pump Assy. - Nova PV, 230V
	1-280-0015-03	Pump Assy. - Nova PV, 230V, 50 Hz, International
7	9-445-0300-02	Motor - Nova PV Pump, 115V
	9-445-0325-02	Motor - Nova PV Pump, 230V
	9-445-0325-03	Motor - Nova PV Pump 230V, 50Hz, International
8	1-183-0021-01	Pump Housing Kit - Nova PV
9		Coil & Compressor Assy. (Refer to Coil & Compressor Replacement Parts List)
10	9-598-5010-02	Dura Clamp - Shut-Off for Auxiliary Tank Hose
11	1-181-0002-01	Tank Assy.-5 Gallon Auxiliary (SS5-30)
	1-381-0044-01	Tank Assy.-2.5 Gallon Auxiliary (SS3)
12	1-183-0023-01	Filter Canister Kit (Including 3 Liners & Diffuser) (SS5-30)
	1-181-0047-01	Filter Bag Assy. (SS3)
13	1-130-0010-01	Filter Canister with Lid only (SS5-30)
	1-130-0008-01	Lid Assy. For Filter Canister (SS5-30)
14	1-130-0004-01	Diffuser Pad 3 1/2" Dia. X 1/4" Thk. (SS5-30)
15	1-130-0006-01	Filter Liner (Foam Media 14 1/2" x 7 3/8 x 3/4" (SS5-30)
	9-590-0009-01	Filter Bag (SS3)
16	1-183-0001-01	Filter Liner Kit (12 Liners & 3 Diffusers) (SS5-39)
	1-183-0001-02	Filter Liner Kit (16 Liners & 6 Diffusers) (SS5-39)
17	1-114-0014-01	Level Control Tube (For use with auxiliary tank)
18	1-203-0017-01	Hole Cover Assy - Alco - Miser (Mirror Finish SS5-30)
19	1-210-0001-01	Impeller (White, 60Hz)
	1-210-0001-02	Impeller (Yellow, 50Hz)
	1-210-0001-03	Impeller (Green, Low Velocity)
20	9-416-5501-03	Amber Lamp - Low Alcohol Supply Indicator

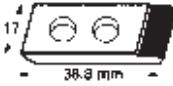
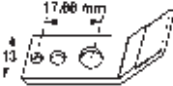

Item	Part Number	Description
1	0-380-0002-22	Alco-Miser, 230V (Complete) Model A-20"
2	0-181-0001-02	Valve Assy. - Solenoid, 230V
3	0-302-0027-01	Tower Assy.
4	0-181-0004-01	Sensing Cap Assy.
5	0-102-0019-01	Tower Cover (Clear Plastic)
6	9-416-5525-03	Green Neon Lamp (230V) "On"
7	9-416-5525-02	Amber Neon Lamp (230V) "Balanced"
8	5-181-0131-01	On/Off Switch
9	9-430-0425-02	Relay (230V) E-37
10	9-590-0800-01	Filter - Alcohol
11	0-183-0003-01	Hydrometer
12	0-181-0005-01	Safety Can Fitting
13	9-597-0101-01	Safety Can - 5 Gal.
14	0-181-0009-01	Balance Shelf Assy. For Safety Can
15	9-499-0002-02	Proximity Switch
16	9-598-0051-01	Tubing - Yellow, 1/8" I.D. x 1/4" O.D.
17	9-598-0107-02	Tubing - Clear Poly, 1/2" I.D. x 3/4" O.D.
18	9-598-5001-14	Clamp - Hose, Plastic 1/2"
19	9-598-0070-04	Tubing - Latex 3/16" I.D. x 3/8" O.D.
20	9-598-5001-04	Clamp - Hose, Plastic 3/8"
21	0-102-0017-01	Elbow - Orifice (Venturi)
22	0-102-0015-01	Nozzle - Sample Tube
23	9-407-0201-12	Fuse (0.75 Amp/250V) 1/4" x 1 1/4" (UL 3AG)

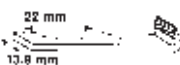
Heidelberg Gripper Fingers

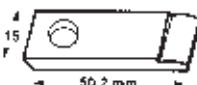
Cylinder	Grip Texture	Mfr. I.D./RGS I.D.	Press
Imp. Cyld. Finger WxL: 19 x 84.25mm Between Holes Ctr-Ctr: 40mm	D/C	49-011-1027 20/3000	Speedmaster SORD
			
Imp. Cyld. Finger WxL: 15.8 x 84.25mm Between Holes Ctr-Ctr: 40mm	D/C	91-581-827 20/3008	Speedmaster 102 & 72 1990-present
			
Imp. Cyld. after Perfector WxL: 18.9 x 73.75mm Between Holes Ctr-Ctr: 22mm	D/C	91-581-827 20/3009	
			
Imp. Cyld. after Perfector WxL: 16 x 74mm Between Holes Ctr-Ctr: 22mm	D/C	C3-581-727N 20/3033	Speedmaster 102 & 72 1990-present
			
Imp. Cyld. Pad WxH: 20 x 18mm	M/G	91-581-620 20/3001	Speedmaster SORD
			
Imp. Cyld. Pad WxH: 18 x 18mm	M/G	20/3004	
			
Delivery Pad Head size: 18mm Temp. rated: 350°F.	D/C	93-525-310-K02 20/3002	
			
Imp. Cyld. Pads after Perfector Head size: 20mm	M/G	53-711-101 20/3003	
Head size: 18mm	M/G	C3-581-920A 20/3013	
			
End Pad Head size: 20mm Between Holes Ctr-Ctr: 55.5mm	M/G	91-581-621 20/3014/Dr	Drive side
Head size: 20mm Between Holes Ctr-Ctr: 55.5mm	M/G	91-581-622 20/3014/Op	Operator side
			

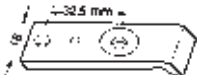
Cylinder	Grip Texture	Mfr. I.D./RGS I.D.	Press
End Pad Head size: 20mm Between Holes Ctr-Ctr: 58.3mm	M/G M/G	20/3028/Dr 20/3028/Op	Speedmaster 72"
			
Perfector Fixed Gripper WxL: 18.9 x 73.75mm	No coating D/C	91-581-827 20/3012 20/3012-D	Speedmaster 72"
			
Perfector Spring Gripper WxL: 17 x 38.8mm	D/C U/C	91-580-337 20/3015-D 20/3015-U	Speedmaster 72"
			
10 or 15 full grippers & 1 "half wide gripper" make a set. To order the "half wide gripper," add "N" to the part number.			
Delivery Finger WxL: 13 x 43mm Between Holes Ctr-Ctr: 17.66mm	D/C U/C	63-014-024 20/3010-D 20/3010-U	MO 19" x 25"
			
Cyld. Finger	D/C U/C	69011-827-K01 20/3011-D 69011-727 20/3011-U	GTO MO
			
Imp. & Transfer Cyld. Finger WxL: 13.9 x 60mm Between Holes Ctr-Ctr: 22mm	52-581-827 D/C	GTO 20/3017	
			
In Feed or Swing Arm Gripper Ranger Drum WxL: 18 x 45.3mm	U/C	27-013-049 20/3018	MO SORSZ 40"
			
Perfector Fixed Gripper WxL: 15 x 50.2mm	No Coating D/C	20/3025 20/3025-D	MO GTO
			
Perfector Spring Gripper WxL: 15 x 35.2mm	D/C U/C	20/3016-D 20/3025-U	
			
10 full grippers & 1 "half wide gripper" make a set. To order the "half wide gripper," add "N" to the part number.			
Imp. Cyld. Finger WxL: 18 x 73.5mm Between Holes Ctr-Ctr: 55.5mm	D/C	11275 20/3005	RVO
			

Cylinder	Grip Texture	Mfr. I.D./RGS I.D.	Press
Imp. Cyld. Finger WxL: 18 x 73.5mm Between Holes Ctr-Ctr: 55.5mm	D/C	S1127F 20/3005	SBD

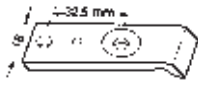

Imp. Cyld. Finger WxL: 18 x 76.5mm Between Holes Ctr-Ctr: 32.5mm	D/C	20/3006	Original
---	-----	---------	----------



Imp. Cyld. Finger WxL: 18 x 73.5mm Between Holes Ctr-Ctr: 36mm	D/C	S1127F (New) 20/3007	KORD-64 SBB, SBG SB, S
---	-----	-------------------------	------------------------------



Imp. Cyld. Finger WxL: 18 x 73.5mm Between Holes Ctr-Ctr: 36mm	D/C	03-011027F (Old) 20/3007	KORD-64 SBB, SBG SB, S
---	-----	-----------------------------	------------------------------



Imp. Cyld. Finger	D/C U/C	222-011-032 20/3019-D 20/3019-U	TOK Reconditioned only
--------------------------	------------	---------------------------------------	-------------------------------



D/C=diamond cut; U/C=urethane coating; M/G=machine grooved

Delivery Finger WxL: 12.6 x 54.2mm Between Holes Ctr-Ctr: 22.3mm	D/C	10404F 20/3020-D	SBB, SBG, SBD, S-Line
---	-----	---------------------	--------------------------

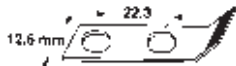

Delivery Finger WxL: 12.6 x 54.2mm Between Holes Ctr-Ctr: 22.3mm	U/C	1404F 20/3020-U	SBB, SBG SBD, S-Line
---	-----	--------------------	-------------------------

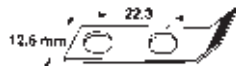

Feed Board WxL: 9.5 x 49.8mm Between Holes Ctr-Ctr: 12mm	D/C U/C	34-020-035F 20/3021-D 20/3021-U	GTO, KSB, KS, KSBA 46-52"
---	------------	---------------------------------------	---------------------------------

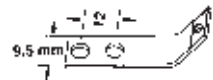

Feed Board WxL: 9.5 x 49.8mm Between Holes Ctr-Ctr: 12mm	D/C U/C	20/3022-D 20/3022-U	KSB, KS, KSBA, Letterpress
---	------------	------------------------	----------------------------------

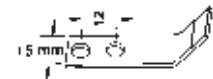

Delivery Finger WxL: 12.6 x 54.4mm Between Holes Ctr-Ctr: 22.3mm	D/C U/C	20/3023-D 20/3023-U	KORD, GTO 52"
---	------------	------------------------	------------------

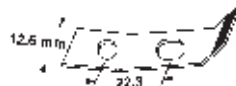

Cylinder	Grip Texture	Mfr. I.D./RGS I.D.	Press
Rack Finger WxL: 12.6 x 76mm Between Holes Ctr-Ctr: 19mm	D/C U/C	1451 20/3024-D 20/3024-U	S-LINE, SDB

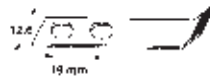

Rack Finger Cover Plate WxL: 12.6 x 60mm Between Holes Ctr-Ctr: 19mm	D/C U/C	Cover plate for 20/3024 20/3029 20/3029	S-LINE, SDB
---	------------	---	-------------

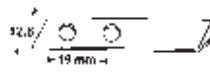

Feed Finger WxL: 9 x 45.3mm Between Holes Ctr-Ctr: 7.8mm	D/C U/C	03-020-035 20/3026-D 20/3026-U	S-LINE, SB, SBG, SBD
---	------------	--------------------------------------	-------------------------

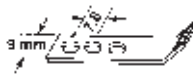

Delivery Bar

Delivery Bar Repair gripper bar. Machine old pad surface oil and screw on a new diamond coated steel pad surface. Reconditioned only.	D/C	20/3027	KORD
---	-----	---------	------

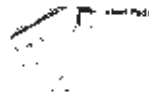

Diamond Covers To improve the gripping texture of each pad. Set of 35	D/C	20/3034	
---	-----	---------	--

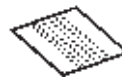

Side Guide Bars

Side Guide Bar 12.371" long	D/C	20/3030	Speedmaster
---------------------------------------	-----	---------	-------------



Side Guide Bar 14.2" long	D/C	20/3031	
-------------------------------------	-----	---------	--



Plate Clamp

Strips Length: 200mm/7.875"	D/C	20/3032-1	
Length: 134mm/5.275"	D/C	20/3032-2	
Length: 80mm/3.150"	D/C	20/3032-3	



Diamond coated spring steel strips that can be bonded to the clamping bar to give a new clamping surface

Paster-Parallel-Sheeteer Brushes



Part#	Description
04250	Heidelberg Gripper Pad Sweeper 48" L x 2" W x 3-1/2" nylon trim
04075	Double Parallel Brush 22-1/2" L x 1-1/2" W x 3/4" thick Angle Filled 1-1/2" trim Horse Hair or Nylon Fill
04077	Double Parallel Brush 22-1/2" L x 3" W x 3/4" thick Angle Filled 2" trim Horse Hair or Nylon Fill

Cut Off & Splicer Brushes



Part#	Description
04071	41-3/8" L x 1" overall trim .025 Nylon Fill—Metal Black Strip
04072	41-3/4" L x 1-3/8" overall trim .027 Nylon Fill—Metal Black Strip
04073	39-3/8" L x 1-7/16" overall trim .027 Nylon Fill—Metal Black Strip
04074	42" long x 1-1/2" overall trim .018 Nylon Fill—Metal Black Strip

Refillable Brushes



Part#	Description
04214	G-16 Page Folder Brush (Chopper Brush) (Baker Perkins)
04205	Stobb VSB Bundler Tall Brush Refill
04503	Royal Zenith Pulley Wheel Refill Vit Sheet Refill Sheet Cleaner

Dampening Brushes

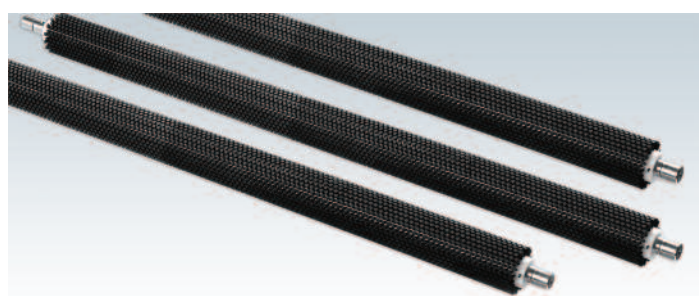

Part#	Press	Coils
04050	Harris M-1000	55.0
04053	Harris M-1000A	65.0
04055	Harris M-110	34.0
04144	Harris M-120	41.0
04054	Harris M-200	52.0
04234	Harris M-300	56.0
04291	Harris M-400	46.0
04169	Harris M-845	51.0
04230	Harris V-15	47.0
04228	Harris 900	61.0
04224	Harris 936	47.0
04290	Harris 954	72.0
04233	Harris 9000	86.0
04151	Baker Perkins G-14	72.0
04170	Baker Perkins G-16	72.0
04152	Baker Perkins G-16	120.0
04153	Baker Perkins G-16	105.0
04154	Baker Perkins G-16	68.0
04174	Timson T78324	72.0
04175	Timson T006002	83.0
04148	Goss C-700	75.0
04225	Goss C-150	46.0
04227	Goss C-700	85.0
04232	Goss Suburbanite	
04235	Goss Community	
04236	Goss Metro	
04165	Hantscho	63.0
04160	Hantscho	33.0
04163	Hantscho	50.0
04162	Hantscho	45.0
04164	Hantscho	51.0
04142	Hantscho	45.0
04143	Mitsubishi L600	68.0
04155	Mitsubishi L700	54.0
04146	Toshiba TV Guide	80.5
04156	Toshiba 206W26	80.5
04157	Toshiba 248T0301	100.0
04171	Toshiba 248T0301	70.5
04172	Toshiba 248T0301	72.5
04173	Toshiba 248T0301	91.5
04237	Color King	61.0
04238	MAN/Roland	43.0

Feeder and Delivery Wheels



Part#	Manufacturer's Part#	Description
04084	Heidelberg	2-3/8" dia. x 1/4" Arbor Hole x 29/64" W x .004 Crimped Natural Nylon Fill
04085	Heidelberg	2-3/8" dia. x 1/4" Arbor Hole x 29/64" W x .008 Crimped Natural Nylon Fill
04088	Heidelberg	2-3/8" dia. x 1/4" Arbor Hole x 29/64" W x Horse Hair Fill
04303	Komori 444-1341-124	1-7/8" dia. x 1/4" Arbor Hole x .550" W x Horse Hair Fill
04322	Komori 261-1434-400	1-7/8" dia. x 1/4" Arbor Hole x .550" W x Goat Hair Fill
04738	Komori 046-3363-05I	1.84" dia. x .236" Arbor Hole x .550" W x .004 Crimped Natural Nylon Fill
04739	Komori 046-3363-05H	1.84" dia. x .236" Arbor Hole x .550" W x Horse Hair Fill
04302	Man Roland 3E-903	1-7/8" dia. x 1/4" Arbor Hole x .550" W x Goat Hair Fill



Rubber Wheel - Soft for KBA Rapida 104-142-162

Part# RWKBAS

Rubber Wheel - Bearing for KBA Rapida 104-105

Part# RWKBAO

Part#	Manufacturer's Part#	Description
04303	Man Roland 3T-69	1-7/8" dia. x 1/4" Arbor Hole x .550" W x Horse Hair Fill
04321	Mabeg 04-012116-000	2-1/8" dia. x 1/4" Arbor Hole x .540" W x Horse Hair Fill
04084-1	Miller 039602	2-7/16" dia. x 5/16" Arbor Hole x 29/64" W x .004 Crimped Natural Nylon
04300	Miehle 123595	2-5/8" dia. x 5/16" Arbor Hole x .640" W x Horse Hair Fill
04604	Shinohara 2P52 Press	1-1/4" dia. x .276" Arbor Hole x 1/2" W x Goat Hair Fill
04605	Shinohara	1.874" dia. x .276" Arbor Hole x 1/2" W x Goat Hair Fill
04590	Bobst Pulley Wheel	3.18" dia. x 1.25" Arbor Hole x 1.10" W x Horse Hair Fill
04593	Planetta	2.60" dia. x 1" Arbor Hole x 1-3/8" W x Pony Hair Fill, Bearings Included

Hold Down Brushes

Part#	Manufacturer's Part#	Description
03115	Komori 444-1665-005	Spring Steel, 23mm-15mm Angled Trim x Horse Hair Fill
03129	Man Roland 3D-38	Carbon Steel Holder with Slot, 7/8" Trim x .010 Level Natural Nylon Fill
03150	Man Roland BX1185MTG	Steel Rod with Brass Holder, 1-1/4" Trim x .016 Level Natural Nylon Fill
04381	Man Roland 3E-902	Carbon Steel Holder, 1"-9/16" Angled Trim x .010 Level Natural Nylon Fill

Wash Up Brush Roller For Heidelberg



For automatic blanket cleaner systems.

Made to exact OEM specifications.

Diamond Cut® Paper Knives



High quality Diamond Cut® paper knives for guillotine cutters and 3 knife trimmers are manufactured to precise OEM specifications in the following grades of steel:

High Carbon High chrome (HC,HC)
18% Tungsten High Speed Steel (HSS)
Maxilife™ Carbide

CUTTER NAME	INCHES	MILLIMETER
Adast Maxima	.177 x .394	4.5 x 10
Adast Maxima	.551 x .551	14 x 14
Brackett	.551 x .551	14 x 14
Brackett	.740 x .740	19 x 19
Campeador	.623 x .623	15.8 x 15.8
Challenge Guillotine	.495 x .495	12.7 x 12.7
Challenge Three Knife	.125 x 13.5	3 x 343
Chandler & Price	.495 x .495	12.7 x 12.7
Comeca	.197 x .629	5 x 16
Como	.118 x .557	3 x 14
Como	.740 x .740	19 x 19
Como	.787 x .787	20 x 20
Consolidated	.155 x .712	4 x 18
Consolidated / Comeca / F.T.P.	.197 x .629	5 x 16
Dexter / Lawson	.740 x .740	19 x 19
Duplo	.680 x .680	17.3 x 17.3
EBA / Multicut	.551 x .551	14 x 14
Heidelberg / Polar	.174 x .390	4.5 x 10
Herold	.197 x .709	5 x 18
Horizon Guillotine	.394 x .394	10 x 10
Horizon Guillotine	.472 x .472	12 x 12
Horizon Three Knife	.276 x .590	7 x 15
Horizon Three Knife	.472 x .472	12 x 12
Ideal	.236 x .745	6 x 19
Ideal	.551 x .551	14 x 14
Ideal	.551 x .551	14 x 14
Imperial / Embassy	.155 x .386	4 x 9.8
Imperial / Embassy	.315 x .775	8 x 19.7
Itoh	.623 x .623	15.8 x 15.8
Kolbus Three Knife	.155 x .787	4 x 20
Kolbus Three Knife	.394 x .394	10 x 10
Kolbus Three Knife	.787 x .787	20 x 20
Lawson Pacemaker	.740 x .740	19 x 19
Lawson Regent	.585 x .585	15 x 15
Lawson Three Knife	.155 x .945	4 x 24
Lawson Three Knife	.155 x 1.625	4 x 41
Lawson Three Knife	.155 x 2.375	4 x 60
MartinYale / Franklin Spaulding	.495 x .495	12.7 x 12.7
MartinYale / Franklin Spaulding	.551 x .551	14 x 14
Maxima	.551 x .551	14 x 14
MBM Michael Business Machine	.236 x .745	6 x 19
MBM Michael Business Machine	.551 x .551	14 x 14
Michael Miracle / Mandelli / LMM	.623 x .623	15.8 x 15.8
Muller Martini Three Knife	.394 x .394	10 x 10
Muller Martini Three Knife	.590 x .590	15 x 15
Muller Martini Three Knife	.394 x .787	10 x 20
Perfecta Guillotine	.174 x .390 wavy	4.5 x 10 wavy
Perfecta Guillotine	.394 x .394	10 x 10
Perfecta Guillotine	.623 x .623	15.8 x 15.8
Perfecta Guillotine	.197 x .394	5 x 10
Perfecta Three Knife	.623 x .623	15.8 x 15.8
Pivano Guillotine	.197 x .394	5 x 10
Pivano Guillotine	.394 x .394	10 x 10
Pivano Three Knife	.155 x .472	4 x 12
Polar	.174 x .390 wavy	4.5 x 10 wavy
Prism	.174 x .390 wavy	4.5 x 10 wavy
Pro Cut	.174 x .390 wavy	4.5 x 10 wavy
Pro Cut	.495 x .495	12.7 x 12.7
Reliant	.623 x .623	15.8 x 15.8
Royal Zenith Guillotine	.197 x .394	5 x 10
Royal Zenith Guillotine	.394 x .394	10 x 10
Royal Zenith Guillotine	.623 x .623	15.8 x 15.8
Royal Zenith Three Knife	.623 x .623	15.8 x 15.8
Royo / Campeador	.315 x .787	8 x 20
Royo / Campeador	.623 x .623	15.8 x 15.8
Saber	.748 x .748	19 x 19
Schimaneck	.197 x .495	5 x 12.7
Schimaneck	.197 x .62	5 x 15.8
Schneider Senator	.18 x .384	4.5 x 9.8
Schneider Senator	.197 x .745	5 x 19
Schneider Senator	.551 x .551	14 x 14
Schneider Senator	.118 x .472	3 x 12
Seybold	.74 x .74	19 x 19
Seypa	.197 x .394	5 x 10
Seypa	.394 x .394	10 x 10
Seypa	.623 x .623	15.8 x 15.8
Sheridan VT Trimmer	.495 x .495	12.7 x 12.7

CUTTER NAME	INCHES	MILLIMETER
Stahl / VBF / Hoerauf	.155 x .51	4 x 13
Stahl / VBF / Hoerauf	.155 x 1.181	4 x 30
Stahl / VBF / Hoerauf	.155 x 1.693	4 x 43
Swiss Hydracut	.551 x .551	14 x 14
Triumph / Trojan	.236 x .745 bevel w/h	6 x 19 bevel w/h
Triumph / Trojan	.551 x .551 w/holes	14 x 14w/holes
Wohlenberg Guillotine	.155 x .394 wavy	4 x 10 wavy
Wohlenberg Guillotine	.155 x .688	4 x 17.5
Wohlenberg Guillotine	.155 x .712	4 x 18
Wohlenberg Guillotine	.512 x .512	13 x 13
Wohlenberg Guillotine	.585 x .585	15 x 15
Wohlenberg Guillotine	.74 x .74	19 x 19
Wohlenberg Guillotine	.118 x .433	3 x 11
Wohlenberg Three Knife	.155 x .945	4 x 24
Wohlenberg Three Knife	.155 x 1.625	4 x 41
Wohlenberg Three Knife	.155 x 2.375	4 x 60
Wohlenberg Three Knife	.118 x .433	3 x 11
Wohlenberg Three Knife	.155 x .945	4 x 24
Wohlenberg Three Knife	.155 x 1.625	4 x 41
Wohlenberg Three Knife	.155 x 2.375	4 x 60

Plastic Jogger Block

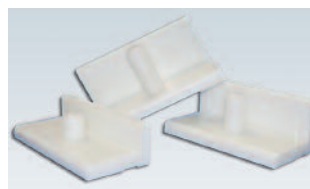

Made in the USA of heavy-duty Kimoplastic™ – Strong magnetic base helps jog bottom sheets perfectly – durable construction – rounded handle accommodates a natural grip.

Part# PJ 618 Jogging block

Bladesaver® Plastic Cutting Sticks

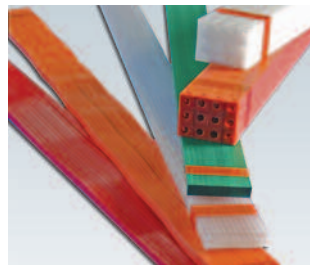

Made with a special grade of material called Kimoplastic™, the most durable, non-abrasive and cost effective material designed for paper cutting. The natural lubricity and self-healing characteristics of Kimoplastic™ keeps the Bladesaver® stick in the channel long after others have been rolled or changed.

Standard White, Standard Red, Heavy Duty Red/Heavy Duty Green, Premium/Red Premium, Herculite Qtps of 12

Magnetic Clamp Pad



Protects paper stock from clamp marks. 1 package contains 2 pads. Dimensions – 1 pad = 3" x 15" long

Part# CP1000

Replacement Lamps For Paper Cutters



Polar cutters
Challenge Cutters
Lawson Cutters
Reliant Paper Cutters
Senator Paper Cutters
Synder Senator Paper Cutters
Triumph & others

Plastic Knife Guard

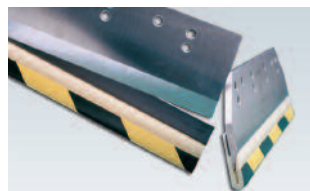

Protects the operator, makes knife handling safe and provides a safeguard during maintenance procedures.

Vs ZERO Series



100% VOC Free – Earth Friendly - Made of 100% vegetable oil, Vs ZERO process inks are suitable for straight printing and perfecting presses, and comply with GraCol 7 and DIN ISO 2846-1 standards. Additionally, these earth-friendly process inks deliver effortless, trouble-free printing, producing brighter

colors and greater print contrast. Including environmental sustainability in every step of your printing operation with Van Son's VS Zero process inks sends a powerful message to your customers that you are serious about your company's footprint.

Vs1 Series



Quality Ink for True Economy - Vs1 process inks perform flawlessly on any size press and offer the features you've come to expect from ink bearing the Van Son name – intense, consistent color and rapid setting and drying speed, resulting in exceptional rub and scuff resistance. Vs1 process inks

also boast the lowest amount of water pickup, allowing for improved press stability and exceptional transfer properties. Vs1 process inks are specifically designed to deliver Van Son quality at a very competitive price to make your printing life easier – and more profitable.

The Vs3 Process Inks Series



The Vs3 Series is a family of process inks incorporating three specific ink options designed to satisfy your total printing and production requirements. Choose one or all three to provide the flexibility and versatility that best fits your unique printing application.

Vs3 Process Inks

Vs3 process inks are built to handle your everyday printing and production needs. Its balanced pigment range will give you the ultimate in on-press color stability and consistent run-ability – from your shortest to your longest runs. Vs3 process inks set fast and dry hard to allow for immediate post-print processing. Experience faster make-readies and increased productivity with Vs3 process inks.

Vs3 XS Process Inks

Vs3 XS process inks were developed to offer a more robust version of the versatile and vibrant Vs3 process inks. Benefits of Vs3 XS include an extra-strong, balanced pigment range, enhanced formulation for faster setting and drying, and modified stability for balanced printing and 4+4 perfecting control. Best of all, the Vs3 XS process inks are interchangeable with the Vs3 process inks to allow for complete customized color capability.

Vs3 Hard Dry Process Inks

When your applications require exceptionally fast and hard surface drying along with maximum rub resistance, Vs3 HD process inks become the ideal choice. On even the most demanding abrasive substrates, Vs3 HD process inks will dry to an extremely resilient surface. Additionally, Vs3 HD process inks will demonstrate the absolute highest lithographic performance, delivering intense, consistent color and trouble-free printing on all your offset presses.

Vs4 Waterless Series



For All Waterless Presses - At Van Son, we recognized the importance of combining the perfect balance between technology and ingenuity when developing our Vs4 process inks for waterless printing. Known to have the industry's widest critical tone temperature (CTT), Vs4

process inks resist toning and mottle within a broad range – 63°F – 97°F. User-friendly and trouble-free, Vs4 process inks allow you to print heavier ink films with higher color densities, lower dot gains, and exceptional rub resistance. Compatible with all waterless plates and presses, Vs4 process inks are the ideal choice for premium dry offset printing.

Vs9 UV Series



For UV Versatility - Vs9 UV process inks offer a proprietary UV system that delivers outstanding cure, high performance, and overall reliability. With maximum cure for fast finishing along with a vibrant color range, Vs9 UV process inks will exceed your expectations, as well as those of

your customers. The exceptional run-ability demonstrates ease of use similar to that of conventional lithographic inks with the versatility needed for printing on a broad range of media that include plastic, paper, foil and other non-porous substrates. Vs9 UV process inks are created specifically to make your UV printing experience effortless, productive, and profitable.

Vs Series Pantone®

For the Perfect Color Match - The PANTONE® Matching System® addresses the evolving, precise demands of today's printing industry. Our Vs Series Pantone mixing bases offer a wonderful spectrum of authentic, vibrant colors. Suitable for use on a broad range of substrates, they also serve up a host of impressive characteristics that include high gloss, precision dot sharpness, and extraordinary rub resistance. The Vs Series Pantone is your answer for premium high-performance that produces vibrant results. For colors that match today's needs, choose Van Son's Vs Series PANTONE colors.

Contract Proofing Papers

Satin ract Base

260 gram satin finish proofing paper. Commercial shade. Features wide color gamut, instant dry. No OBA's.

Pub 160

Look and feel of an actual offset press sheet while maintaining all of the necessary coating properties to allow it to be used for contract proofing. This low gloss proofing paper has minimal optical brighteners to mimic the spectral curve of a #3 press sheet.

Gloss Contract Base

7 mil, commercial shade. Instant dry.

Press White 160 & 195

160 & 195 gram, neutral white. Designed to simulate an offset sheet and is specially coated to achieve a very low L* with UltraChrome inks. Thermal/piezo printers. Dye or pigmented inks. No OBA's.

Proof Satin 220

An instant dry, wide gamut, proofing paper. It uses a single pass patented microporous coating technology and provides an excellent surface to hold the darkest of black points and minimizes bronzing while using up to 30% less ink over competitive medias. No OBA's.

White Satin190

190 gram, high resolution paper with a very smooth surface and greater color gamut. Instant dry, neutral white. Special coating minimizes pigmented bronzing.

White Satin 230

230 gsm version of White Satin 190.

White Satin 290

290 gsm version of White Satin 190.

Gloss/DP

9 mil heavy weight photo-grade gloss finish proofing paper. Features wide color gamut, instant dry. Minimal OBA's.

Semi-Matte/DP

Same qualities as our Gloss/DP with a semi-matte finish. Minimal OBA's.

Gloss/EXR

7 mil, instant dry. Thermal/piezo printers. Dye or pigmented inks. Bright white paper ideal on all printers for proofing, poster, or high end reproductions.

Semi-Matte/EXR

Same qualities as our Gloss/EXR with a semi-matte finish.

Proof Semi-Matte / WRDS

140 gram and 160 gram, water resistant, double sided. Thermal/piezo printers. Double-sided high end proofs. Recommended for dye inks and in sheet sizes. Rolls not recommended as will yield too much curl.

Specialty Proofing/Film

Super Clear/HD

5 mil, instant dry dimensionally stable. Features high densities for film positives, overlays, and die lines. Water resistant.

Ultra Clear/IJ w/stripes

Instant dry. Thermal/piezo printers. Dye or pigmented inks. Features high densities for overlays, die lines, and film positives.

JPS4

4 mil single-sided matte polyester film. Excellent for die lines & line drawings.

Quality Matte Coated Papers

Premium Matte 230

230 gram, 60 lb coated single-sided matte paper. Neutral shade without added brighteners.

Color Bond

24 lb. Production coated bond.

Proof Paper MW/24

Premium coated 92 gram, medium-weight paper. Instant dry. Lightweight for easy folding.

Matte Paper LH31

120 gram, intermediate-weight paper. Features premium coating and base paper. Instant dry. Thermal/piezo printers. Dye or pigmented inks.

Matte Paper HW42

140 gram, heavy-weight paper. Features premium coating and base paper. Instant dry. Thermal/piezo printers. Dye or pigmented inks.

Matte Paper SH52

180 gram, super-heavyweight paper. Features premium coating and base paper. Instant dry. Thermal/piezo printers. Dye or pigmented inks.

Matte Paper DW62

62 lb., 230 gram premium coated matte paper.

Double Sided Papers

Proof Paper DS100

100 gram, 26 lb double-sided matte paper. Water resistant. Thermal/piezo printers. Dye or pigmented inks. Recommended for double-sided proofing. Premium constructed paper reduces curl, folds easily. Quality coating yields smooth surface for high resolution with lower dust to reduce head clogging.

Sheets: DS100

Rolls: DS102 = 2" core

DS103 = 3" core

DS106 = 6" core

Proof Paper DS110

Designed for double sided imposition proofing. DS-110 is ideal for the: Hyphen ImpoProof (Two Canon's), the PreProofer (two Epson's), and the KwikFlip.

Proof Paper DS120

120 gram version of our DS100 paper. Available in sheets only.

Matte DS-44

165 gram, double-sided matte paper. Available in sheets only.

Premium Photo Papers

Semi-Matte/DP

9 mil heavy weight photo-grade paper. Brightness level 92. Features wide color gamut, instant dry. Recommended for HP and Canon printers with UV inks and Epson Ultrachrome Inks using Photo Black.

Gloss/DP

9 mil heavy weight photo-grade gloss finish paper. Features wide color gamut, instant dry. Recommended for HP and Canon printers with UV inks and Epson Ultrachrome Inks using Photo Black.

Premium Luster 260

9 mil, 260 gram, premium bright white paper with a low glare surface. Simulates the weight and feel of traditional photographic paper. Features wide color gamut, instant dry. Thermal or piezo printers. Dye or pigmented inks.

Gloss/EXR

7 mil, instant dry. Thermal/piezo printers. Dye or pigmented inks. Bright white paper ideal on all printers for proofing, poster, or high end reproductions.

Semi-Matte/EXR

Same qualities as our Gloss/EXR with a semi-matte finish.

Premium Glossy 200

Glossy version of Premium Silky 200. Thermal Dye inks only.

Giclee Fine Arts

300 Fibre Photo Gloss

300 gsm. Fine Art & Photo. Microporous surface. Bright White/Acid-Free/Giclee.

300 Fibre Photo Gloss Natural

300 gsm. Fine Art & Photo. Microporous surface. Natural White/Acid-Free/Giclee.

300 Fibre Photo Satin

300 gsm. Fine Art & Photo. Microporous surface. Bright White/Acid-Free/Giclee.

Fine Arts Premium Matte Canvas

20 mil, flexible cotton canvas. Water resistant. Thermal/piezo printers.

280 Fibre Photo Matte

280 gsm. Fine Art & Photo. Ultra smooth surface. Bright White/Acid-Free/Giclee.

315 Smooth Art Cotton

315 gsm. Fine Art & Photo. Smooth white surface. 100% Cotton/Acid-Free/Giclee.

230 Premium Matte

230 gsm. Fine Art & Photo. Smooth white surface. 100% Cotton/Acid-Free/Giclee.

240 Smooth Art Duo (two Sides)

240 gsm. Fine Art & Photo. Smooth white surface. 100% Cotton/Acid-Free/Giclee.

315 Velvet Art White

315 gsm. Fine Art & Photo. Soft-Textured surface. Natural White/Acid-Free/Giclee.

315 Velvet Art Natural

315 gsm. Fine Art & Photo. Soft-Textured surface. Acid-Free/Giclee.

315 Coarse Art Natural

315 gsm. Fine Art & Photo. Rough Textured. Natural White/Acid-Free/Giclee.

Self Adhesive

Micro Poly W/Adhesive

8 mil adhesive glossy microporous Polypropylene. Brilliant Color, water resistant.

White Vinyl/WP

3.5 mil, adhesive backed. Water resistant. Thermal/piezo printers. Dye or pigmented inks.

Matte Adhesive / MA36

36 lb. matte paper with adhesive-backed coating. Universal, works on all printers.

Banner, Poster & Signage

Microfab WR-11

Microporous coated fabric 11 mil. Water resistant. Universal compatibility.

Event Banner/WP

15 mil scrim vinyl/blocker. Economical banner ideal for indoor or outdoor signage. Water resistant. Universal compatibility.

Proof Banner/WP

15 mil scrim vinyl/blocker. Quality flexible vinyl is ideal for indoor or outdoor signage. Water resistant. Universal compatibility. Added light blocking layer.

Proof Banner/DS

Double sided version of Proof Banner/WP. Water resistant. Universal compatibility.

Dupont Tyvek/WP

Tough and durable, can be grommeted. Water resistant. Universal compatibility.

Poly Pro/WP

9 mil polypropylene film with water resistant coating. Works on all printers.

Micro Poly

8 mil glossy microporous Polypropylene. Brilliant Color, water resistant.

Rigid PVC

15 mil PVC. Brilliant color. Water resistant.

Polycarbonate Clear

10 mil clear. New coating reduces color shift, higher resolution prints. Faster drying time. Thermal/piezo, dye & pigmented inks.

Matte Poster Board / Luster Poster Board

22 mil. Instant dry. Thermal/piezo printers. Dye or pigmented inks.

Back Lite

Micro Backlite

9 mil microporous front print. Water resistant.

Universal Backlite

5 mil. Front print water resistant coating with pigmented inks. Universal.

A

Absorbent Socks, Mats, Drum Covers19
 Addition Pens18
 Alcohol Testers19
 Anilox Coater End Seals & Gaskets . 7,8,9,10
 Anti Dry anti skinning spray39
 Anti Marking Jackets33

B

Banner Material54,55
 Bearing Puller21
 Blanket Saver21
 Blanket Scrubber21
 Box Cutters21
 Brush Rollers50,51
 Brush Wheels4
 Brush Wheels51
 Bulbs5
 Buttons5

C

Cheese Cloths19
 Chemicals40,41,42,43
 Clean It All Purpose Pressroom Cleaner . .39
 Clean Up Mats11
 Cloth Rolls Wet, Dry25
 Coater Blades4
 Compressors30
 Conductivity Meters19
 CPC Protective Underlay Foils2
 Cutter Supplies52
 Cutting Sticks52
 Cylinder Jackets3

D

Dampening Covers35
 Dampening Covers Hyton23
 Deletion Gel21
 Deletion Pens18
 Delivery Blowdown Fans4
 Drill Blocks20
 Drills for paper20
 Drum Wrench21
 Dust Masks18

E

Ear Plugs18
 Etching Needles18

F

Feedboard Tapes7
 Feeler Gauge for Heidelberg Presses . 4
 Filters13,14,15,16,17

G

Gloves18

Grease Gun37
 Grease Gun for Heidelberg Presses . . .2
 Gripper Fingers & Pads48,49
 Gripper Pad Gauge4

H

Hand Cleaners17
 Heid Main Air Filters14
 Hickey Picker Products12
 Honers20

I

Image Remover21
 Ink Eliminator15
 Ink Fountain Liners2
 Ink Fountain Side Plate Tapes2
 Ink Fountain Side Plates3
 Ink Knives22
 Ink Van Son53
 Iron for Feedboard Tapes7

J

Jogging Blocks52

K

Klean Wipe23

L

Lay Pins2
 Loupes20
 Lube Clean Open Frame Compound39
 Lubricants37

M

Micrometers19

N

Nubtex Shop Cloths23

O

Oil Gun for Heidelberg Presses2
 O-Rings for Heidelberg Presses4

P

Packing Gauges35
 Packing Plastic & Paper36
 Paper Pile Corners20
 Paper Pucks20
 Perf & Score34
 Perfect Print39
 Perma Lube Cartridges37
 Photex Wipes24
 Pin Wrenches5
 Plastic Pile Separators20
 Plate wipes24
 Press Dollies5
 Press Wash39

Proofing Paper54,55
 Pumps, Royse, Dahlgren, Baldwin5
 Putz Pomade39

Q

Quickmaster Parts6

R

Razor Blades19
 Red 1 Dampening Sleeves24
 Red Runner24
 Revive21
 Roller Cleaning Paste39
 Roller Setting Gauges35
 Royse Parts47

S

Safety Cans45,46
 Scanner wipes24
 Scotch Brite Pads18
 Scraper Cleaner Tabs2
 Scrubs in a bucket17
 Sheet Hold Downs5
 Sheet Separators29
 Silencers (filters)15
 Slow Down Belts6
 Snowtex Cloth Wipes24
 Spigot21
 Sponges21
 Spray Powder33
 Sprayway38
 Springs Pneumatic4
 Static Eliminators32
 Static Tinsel19
 Storage Cabinets44,45
 Suckers26,27,28
 Super Blues33

T

Thermometer19
 Tesamol Tape2
 Torque Wrench20

V

Vacuum Pumps31

W

Wash Up Blades10
 Wash Up Bottles18
 Water Filters14
 Web Knife22
 Web-Lock Splicing Tapes23
 Webril Wipes23
 Wheels Rubber4

Z

Zahn Cups19

FRACTIONAL DECIMAL • METRIC equivalents

To convert inches to millimeters, multiply the inches by 25.4.

To convert millimeters to inches, divide the millimeters by 25.4.

(As established by the American Standards Association.)

inches fractional	decimal	inches fractional	decimal	m/m	inches	m/m	inches	m/m	inches	m/m	inches	m/m	inches	m/m	inches
	1/64 —.0156	33/64 —.5156		1	0.0394	51	2.0079	101	3.9764	151	5.9449	201	7.9134	251	9.8819
	1/32 —.0312	17/32 —.5312		2	0.0787	52	2.0472	102	4.0157	152	5.9843	202	7.9527	252	9.9212
		35/64 —.5469		3	0.1181	53	2.0866	103	4.0551	153	6.0236	203	7.9921	253	9.9606
	3/64 —.0469			4	0.1575	54	2.1260	104	4.0945	154	6.0630	204	8.0315	254	10.0000
1/16	— .0625	9/16	— .5625	5	0.1969	55	2.1654	105	4.1339	155	6.1024	205	8.0709	255	10.0394
	5/64 —.0781	37/64 —.5781		6	0.2362	56	2.2047	106	4.1732	156	6.1417	206	8.1102	256	10.0787
	3/32 —.0938	19/32 —.5938		7	0.2756	57	2.2441	107	4.2126	157	6.1811	207	8.1496	257	10.1181
	7/64 —.1094	39/64 —.6094		8	0.3150	58	2.2835	108	4.2520	158	6.2205	208	8.1890	258	10.1575
1/8	— .1250	5/8	— .6250	9	0.3543	59	2.3228	109	4.2913	159	6.2598	209	8.2283	259	10.1968
	9/64 —.1406	41/64 —.6406		10	0.3937	60	2.3622	110	4.3307	160	6.2992	210	8.2677	260	10.2362
	5/32 —.1562	21/32 —.6562		11	0.4331	61	2.4016	111	4.3701	161	6.3386	211	8.3071	261	10.2756
				12	0.4724	62	2.4409	112	4.4094	162	6.3780	212	8.3464	262	10.3149
	11/64 —.1719	43/64 —.6719		13	0.5118	63	2.4803	113	4.4488	163	6.4173	213	8.3858	263	10.3543
3/16	— .1875	11/16	— .6875	14	0.5512	64	2.5197	114	4.4882	164	6.4567	214	8.4252	264	10.3937
		45/64 —.7031		15	0.5906	65	2.5591	115	4.5276	165	6.4961	215	8.4646	265	10.4331
	13/64 —.2031			16	0.6299	66	2.5984	116	4.5669	166	6.5354	216	8.5039	266	10.4724
	7/32 —.2188	23/32 —.7188		17	0.6693	67	2.6378	117	4.6063	167	6.5748	217	8.5433	267	10.5118
	15/64 —.2344	47/64 —.7344		18	0.7087	68	2.6772	118	4.6457	168	6.6142	218	8.5827	268	10.5512
1/4	— .2500			19	0.7480	69	2.7165	119	4.6850	169	6.6535	219	8.6220	269	10.5905
	17/64 —.2656	25/32 —.7812		20	0.7874	70	2.7559	120	4.7244	170	6.6929	220	8.6614	270	10.6299
				21	0.8268	71	2.7953	121	4.7638	171	6.7323	221	8.7008	271	10.6693
	9/32 —.2812	51/64 —.7969		22	0.8661	72	2.8346	122	4.8031	172	6.7717	222	8.7401	272	10.7086
	19/64 —.2969	13/16	— .8125	23	0.9055	73	2.8740	123	4.8425	173	6.8110	223	8.7795	273	10.7480
5/16	— .3125	53/64 —.8281		24	0.9449	74	2.9134	124	4.8819	174	6.8504	224	8.8189	274	10.7874
		27/32 —.8438		25	0.9843	75	2.9528	125	4.9213	175	6.8898	225	8.8583	275	10.8268
	21/64 —.3281	55/64 —.8594		26	1.0236	76	2.9921	126	4.9606	176	6.9291	226	8.8976	276	10.8661
	11/32 —.3438			27	1.0630	77	3.0315	127	5.0000	177	6.9685	227	8.9370	277	10.9055
3/8	— .3750			28	1.1024	78	3.0709	128	5.0394	178	7.0079	228	8.9764	278	10.9449
	25/64 —.3906	7/8	— .8750	29	1.1417	79	3.1102	129	5.0787	179	7.0472	229	9.0157	279	10.9842
		57/64 —.8906		30	1.1811	80	3.1496	130	5.1181	180	7.0866	230	9.0551	280	11.0236
	13/32 —.4062	29/32 —.9062		31	1.2205	81	3.1890	131	5.1575	181	7.1260	231	9.0945	281	11.0630
	27/64 —.4219	59/64 —.9219		32	1.2598	82	3.2283	132	5.1969	182	7.1654	232	9.1338	282	11.1023
7/16	— .4375	15/16	— .9375	33	1.2992	83	3.2677	133	5.2362	183	7.2047	233	9.1732	283	11.1417
				34	1.3386	84	3.3071	134	5.2756	184	7.2441	234	9.2126	284	11.1811
	29/64 —.4531	61/64 —.9531		35	1.3780	85	3.3465	135	5.3150	185	7.2835	235	9.2520	285	11.2205
	15/32 —.4688	31/32 —.9688		36	1.4173	86	3.3858	136	5.3543	186	7.3228	236	9.2913	286	11.2598
1/2	— .5000	63/64 —.9844		37	1.4567	87	3.4252	137	5.3937	187	7.3622	237	9.3307	287	11.2992
		1.0000		38	1.4961	88	3.4646	138	5.4331	188	7.4016	238	9.3701	288	11.3386
				39	1.5354	89	3.5039	139	5.4724	189	7.4409	239	9.4094	289	11.3779
				40	1.5748	90	3.5433	140	5.5118	190	7.4803	240	9.4488	290	11.4173
				41	1.6142	91	3.5827	141	5.5512	191	7.5197	241	9.4882	291	11.4567
				42	1.6535	92	3.6220	142	5.5906	192	7.5591	242	9.5275	292	11.4960
				43	1.6929	93	3.6614	143	5.6299	193	7.5984	243	9.5669	293	11.5354
				44	1.7323	94	3.7008	144	5.6693	194	7.6378	244	9.6063	294	11.5748
				45	1.7717	95	3.7402	145	5.7087	195	7.6772	245	9.6457	295	11.6142
				46	1.8110	96	3.7795	146	5.7480	196	7.7165	246	9.6850	296	11.6535
				47	1.8504	97	3.8189	147	5.7874	197	7.7559	247	9.7244	297	11.6929
				48	1.8898	98	3.8583	148	5.8268	198	7.7953	248	9.7638	298	11.7323
				49	1.9291	99	3.8976	149	5.8661	199	7.8346	249	9.8031	299	11.7716
				50	1.9685	100	3.9370	150	5.9055	200	7.8740	250	9.8425	300	11.8110



Rosmini Graphic Supply Corp.

Products for the Printing Industry

631-789-4200 • 1-800-235-8605 • Fax 631-789-3551

e-mail: sales@rosminigraphics.com • www.rosminigraphics.com

OXY DRY

to Order
page 32

Anti-Offset Powder



25 kgs boxes

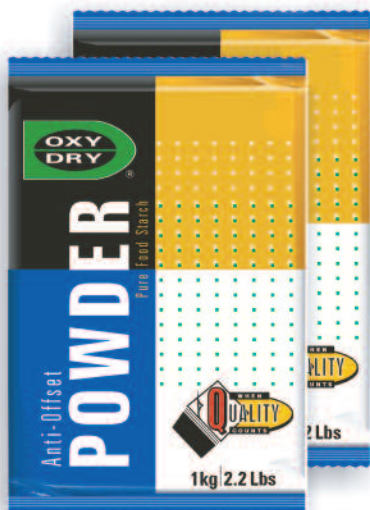

1 kg pouches

www.oxydry.com

UNDERPACKING

PRODUCT SOLUTIONS

For web and sheetfed applications

SunPak

- Precision Engineered
- Dependable Performance
- Uniform Caliper
- Excellent Density
- Resists Wicking
- Anti-Slip Treated
- Local Stock Program
- Custom Cuts

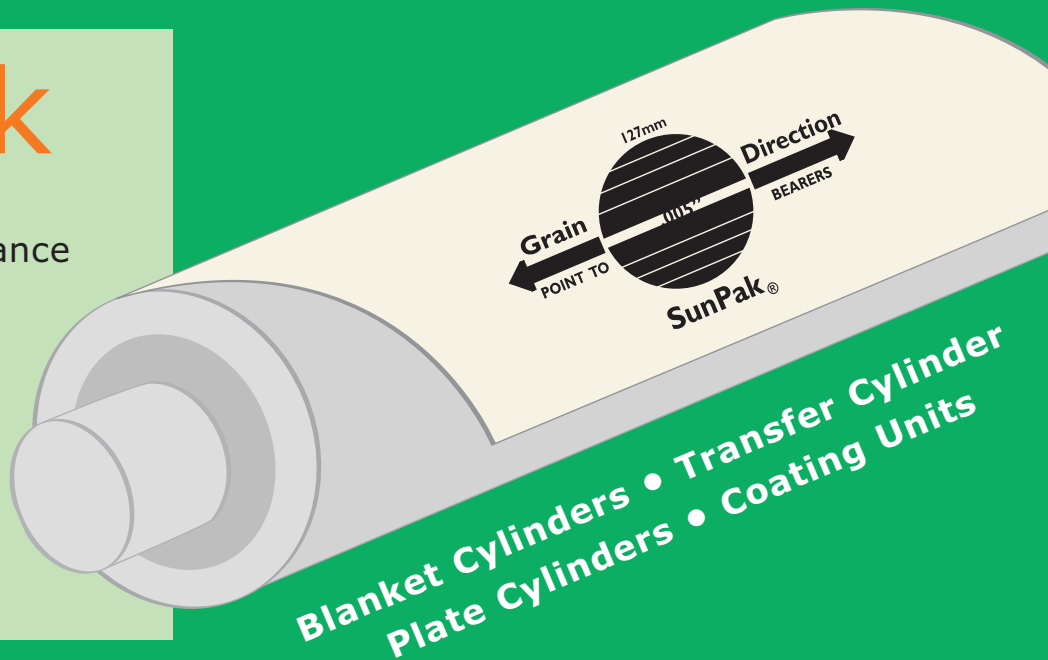

Blanket Cylinders • Transfer Cylinder
plate Cylinders • Coating Units

Ask your Rosmini Graphic Supplies Sales Rep for more details on these other fine quality underpacking materials.

Drumhead — Oiled Tympan — Non-Stenciled

Sta-Put — Oiled Tympan — Caliper-Stenciled

DuraPak — Adhesive Backed Polyester

PolyPak — Non-Adhesive Backed Polyester

Kimlon — Specialty Compressible Underpacking

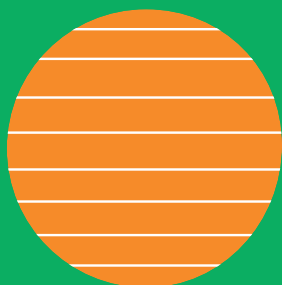

**SunShine
Paper Company LLC**

UNDERPACKING SPECIALISTS